

---

# Model 812



## Reference Manual



Larson Davis Inc.  
1681 West 820 North  
Provo, UT 84601-1341  
Phone: (801) 375-0177  
FAX: (801) 375-0182  
[www.larsondavis.com](http://www.larsondavis.com)  
1812.01 Rev.C

---

---

## Copyright

Copyright 2003 by Larson Davis, Incorporated. This manual is copyrighted, with all rights reserved. The manual may not be copied in whole or in part for any use without prior written consent of Larson Davis, Inc.

## Disclaimer

The following paragraph does not apply in any state or country where such statements are not agreeable with local law:

Even though Larson Davis, Inc. has reviewed its documentation, Larson Davis Incorporated makes no warranty or representation, either expressed or implied, with respect to this software and documentation, its quality, performance, merchantability, or fitness for a particular purpose. This documentation is subject to change without notice, and should not be construed as a commitment or representation by Larson Davis, Inc.

This publication may contain inaccuracies or typographical errors. Larson Davis, Inc. will periodically update the material for inclusion in new editions. Changes and improvements to the information described in this manual may be made at any time

## Equal Opportunity Employer

Larson Davis is an equal opportunity employer and does not discriminate on the basis of race, color, religion, gender, national origin, disability or veteran status.

..Please examine your instrument and record the following information below. You may be asked to give this information in any future communications you have with Larson Davis, Inc.

## Record of Serial Number and Purchase Date

System 812 Serial #: _____	PRM828 Pre-amp. Serial #: _____
Microphone Model #: _____	Microphone Serial # _____
	Purchase Date: _____

---

---

## **Recycling**

Larson Davis, Inc. is an environmentally friendly organization and encourages our customers to be environmentally conscious. When this product reaches its end of life, please recycle the product through a local recycling center or return the product to:

**Larson Davis, Inc.**

**Attn: Recycling Coordinator**

**1681 West 820 North**

**Provo, Utah, USA 84601**

where it will be accepted for disposal











---

---

---

# Table of Contents

<b>Chapter 1</b>	<b>Introduction</b>	<b>1-1</b>
	About This Manual .....	1-2
	About This Chapter .....	1-3
	Formatting Conventions .....	1-3
	Features.....	1-5
	Model 812 Components .....	1-7
	Block Diagram .....	1-10
	Getting Started.....	1-12
	Unpacking and Inspection .....	1-12
	Accessories .....	1-13
	Optional Equipment .....	1-15
	Battery Installation .....	1-17
	Memory Retention.....	1-19
	Environmental Considerations.....	1-20
	Preparing to Use the Model 812 - Connecting the Mic/Preamp.....	1-20
<b>Chapter 2</b>	<b>Overview to Model 812</b>	<b>2-1</b>
	Understanding the Model 812 Keypad.....	2-2
	Turning On the Model 812.....	2-10
	Turning Off the Model 812 .....	2-12
<b>Chapter 3</b>	<b>Calibration</b>	<b>3-1</b>
	Calibrating the Model 812.....	3-1
<b>Chapter 4</b>	<b>Quick Start</b>	<b>4-1</b>
	Setting Parameters Using Function Keys .....	4-1
	Setting Parameters Using Numbers and Other Characters .....	4-3
	Setting Time, Date, and Day parameters.....	4-6
<b>Chapter 5</b>	<b>Performing a Measurement/Reading the Data</b>	<b>5-1</b>
	Taking a Measurement .....	5-1
	SLM.....	5-1
	Lmax-Lmin .....	5-6
	PEAK-UWPK .....	5-7
	Ln .....	5-8
	Leq .....	5-9
	Dose .....	5-9

	BATTERY .....	5-13
	MEMORY .....	5-14
	Stopping the Measurement .....	5-14
<b>Chapter 6</b>	<b>Timed Measurement</b>	<b>6-1</b>
	Using the Timer for Unattended Readings.....	6-1
<b>Chapter 7</b>	<b>History Functions</b>	<b>7-1</b>
	Setting and Viewing Advanced Functions .....	7-1
	Time History.....	7-1
	Time History Data.....	7-3
	Log and Data .....	7-4
	Interval History.....	7-5
	Setting PassBy Functions .....	7-7
<b>Chapter 8</b>	<b>Parameters</b>	<b>8-1</b>
	Parameter Key Access Review.....	8-1
	Entering and Exiting the Setup Menu.....	8-1
	Locating Parameters .....	8-2
	Changing Parameters — Enter, Modify .....	8-3
	Error Messages .....	8-4
	Learning to Store and Retrieve Setup Memory.....	8-4
	Storing a Setup .....	8-5
	Recalling a Setup.....	8-6
	Model 812 Setup Parameters.....	8-7
	System (1-20)    .....	8-7
	Timer (21-27)   .....	8-10
	Lock (28-29)  .....	8-11
	Calibration (35-36)   .....	8-11
	Sound Level Meter (39-50) C .....	8-11
	Dose (51) .....	8-13
	LN Statistical Levels (55-58)  .....	8-13
	Exceedance Level Count (61-65)  .....	8-14
	Interval History (72-79) M	
	Time History (80-87) .....	H8-14
	Print Options (89-112)  .....	8-17
<b>Chapter 9</b>	<b>Memory Usage</b>	<b>9-1</b>
	Determine Storable Data.....	9-1
	Estimating Memory Usage.....	9-3

<b>Chapter 10</b>	<b>Printing a Report</b>	<b>10-1</b>
	Normal Printout Parameters .....	10-1
	Printing Reports .....	10-3
<b>App. A</b>	<b>Specifications</b>	<b>A-1</b>
	Type.....	A-2
	Reference Direction.....	A-2
	Measurement Ranges .....	A-3
	RMS Detector .....	A-3
	Other Detectors.....	A-4
	Reference Level.....	A-4
	Frequency Weightings.....	A-4
	Detector Time Weightings .....	A-7
	Effects of Temperature .....	A-7
	Effects of Humidity .....	A-7
	Limits of Temperature and Humidity .....	A-7
	Microphone Extension Cables.....	A-8
	Optimal Positioning of Instrument and Observer .....	A-8
	AC and DC Outputs .....	A-8
	AC Output.....	A-8
	DC Output.....	A-9
	Reference Frequency.....	A-9
	Stabilization Time.....	A-9
	Microphone Electrical Impedance .....	A-9
	Functions Measured.....	A-10
	Data Storage.....	A-10
	Data Communications.....	A-10
	Digital Display.....	A-10
	Digital Display Resolution.....	A-11
	Display Bargraph .....	A-11
	Real-time Clock/Calendar.....	A-11
	Run-time Clock.....	A-11
	Standards Met.....	A-11
	Power Supply.....	A-12
	Dimensions/Weight (with Microphone, Preamplifier and Battery) .....	A-12
<b>App. B</b>	<b>Serial Port Interface Remote Control</b>	<b>B-1</b>
	Model INT002 Interface Cable.....	B-2
	Daisy Chain Addressing .....	B-3

Commands .....	B-4
History Oriented Commands	
Mode Commands .....	B-5
“Read” Variables .....	B-6
Other Read Commands .....	B-11
Group Read Programming .....	B-12
Setting Parameters .....	B-13
Numeric Parameters .....	B-13
Indexed Parameters .....	B-13
Character String Parameters .....	B-14
Template Parameters .....	B-15
Query Parameters .....	B-16
Histogram Reports .....	B-20
Tailored Report .....	B-20
Error Checking I/O .....	B-23
History Records .....	B-25
Types of History .....	B-25
Advance .....	B-25
Backup .....	B-26
Find .....	B-26
History Data Variables .....	B-26
Interval History Variables .....	B-26
Run Log Variables .....	B-28
Calibration History Variables .....	B-28
Time History Variables .....	B-29
Histogram Table Variables .....	B-29
Print Commands .....	B-30
Error Messages and Warnings .....	B-31

<b>App. C</b>	<b>Glossary</b>	<b>C-1</b>
<b>App. D</b>	<b>Warranty/Customer Satisfaction</b>	<b>D-1</b>



# *Introduction*

Welcome to the Larson Davis Model 812. Your new hand held Model 812 from Larson Davis is a combination *Type 1* precision integrating sound level meter and a statistical data logger that exceeds all worldwide accuracy requirements for the measurement of noise.

The Model 812 measures sound with the ease of operation of a “point and shoot” sound level meter. The latest advances in surface mount technology, air condenser microphones, and internal firmware have been combined in a rugged, lightweight yet extremely versatile unit.

Many sound level meters in the market can create significant measurement errors because of their limited dynamic range, pulse range, and crest factor. The Model 812 does not have these limitations.

Furthermore, its internal firmware is designed to accommodate changing regulations and to overcome sound measurement problems. While the Model 812 is the size of a dosimeter, it may also be used as an environmental noise monitor offering features which will ensure quality measurements for many years.

We invite you to read this manual to get the most out of your new Larson Davis sound level meter.

# About This Manual

---

This manual has 10 chapters and 4 appendices covering the following topics:

- *Chapter 1 - Introduction:* Overview of this user manual and the Model 812's functions and measurement capabilities.
- *Chapter 2 - Overview to Model 812:* Understanding the keyboard and screen, turning the instrument on and off, and checking the battery voltage.
- *Chapter 3 - Calibration:* Using a reference to calibrate the instrument and its importance.
- *Chapter 4 - Quick Start:* Setting parameters, using function keys, and using numbers and other characters.
- *Chapter 5 - Performing a Measurement / Reading the Data:* taking a measurement and becoming familiar with the function keys.
- *Chapter 6 - Timed Measurement:* Using the timer for unattended readings, setting additional parameters, and using the password lock.
- *Chapter 7 - History Functions:* Setting parameters for history settings, interval, passby, time history, and daily history.
- *Chapter 8 - Parameters:* A complete listing of all parameter items and an explanation of their basic functions.
- *Chapter 9 - Memory Usage:* Sizing parameter needs to insure adequate memory for any given measurement.
- *Chapter 10 - Printing a Report:* Turning gathered data into a printed report.
- *Appendix A - Specifications:* A listing of acoustic, electronic, environmental, and physical characteristics of the Model 812.

- *Appendix B - Model 812 Serial Port Interface Remote Control:* Setting interface commands with their syntax.
- *Appendix C - Glossary:* Standard definitions of key terms and concepts used in the sound industry.
- *Appendix D - Index:* Alphabetical listing of all major components of this manual.

## About This Chapter

---

Specifically, this introductory chapter covers the following topics:

- *Formatting Conventions:* Explanation of the fonts and other formatting conventions used in this manual.
- *Model 812 Features:* A listing of the featured characteristic, and capabilities of the Model 812.
- *Model 812 Components:* Description and diagrams of the Model 812 external parts.
- *Getting Started:* Instructions for unpacking, a listing of accessories and optional equipment and initial setup.

## Formatting Conventions

---

This manual uses the following formatting conventions:

Functions accessed by pressing a key on the Model 812 keypad are shown with an icon, for example:

Press **Enter** and then press **Cancel**

In step-by-step directions, the *process* (what you do) is shown in the left column, and the *rationale* (why you do

it) with other cautions and comments are shown in the right column. For example:

Microphone Polarization Voltage is preset by Larson Davis at 200 volts. Should this parameter be incorrect, the Model 812 will not calibrate correctly.

**Step 1** Check the microphone polarization by looking at setup parameter 43. To do this turn on the Model 812, press **RCL SETUP**, **Modify**, **4** and **3**, and **Enter**. The following display will appear:



Mic Polarization  
[200]

Especially important information is shown in italics, for example:

To access items 48-50, *Overall Exchange Rate*, *Overall Threshold*, *Overall Criterion*, press the  key.

## Features

---

The Larson Davis Model 812 meets the requirements of the American National Standards Institute (ANSI) S1.4, International Electrotechnical Commission (IEC) 651, and 804-1985 standards for *Type 1* accuracy and offers the following features:

- Dynamic range of more than 110 dB for error free measurements.
- Impulse measuring range greater than 100 dB.
- Standard microphone allows measurements typically between 30 and 140 dB(A) in one range. Optional microphones allow measurements as low as 20 dB or as high as 190 dB(A). Mic. bias is user selectable: 0, 28, and 200 V.

- Selectable A and C frequency weightings for hearing protector applications.
- Multiple detectors provide simultaneous RMS and PEAK measurements.
- Measures FAST, SLOW, Unweighted PEAK, Weighted PEAK, Impulse,  $L_{eq}$ ,  $L_{DOD}$ ,  $L_{OSHA}$ , Dose, Projected Dose, TWA, Sel ( $L_{ae}$ ),  $L_{max}$ ,  $L_{min}$ ,  $L_n$ , and more.
- User selectable dose exchange rate, criterion, threshold, and reference duration.
- Measures and stores more than 40,000 different DOSE combinations in a single measurement. Allows comparisons of different DOSE standards using the same data.
- Complete data logging capabilities with 64 kB standard memory.
- Passby event data such as time, duration,  $L_{max}$ ,  $L_{eq}$ , SEL, integrated about 10 dB of the maximum.
- Time history sampling periods are user selectable from 1 second up to one sample every 255 seconds.
- Quartz clock/calendar system for data annotation.
- Calibration from front panel (using an appropriate calibration source).
- Easy one step reset of measurement.
- Battery level indication.
- Standard 9V internal alkaline battery life of more than 16 hours (or external power using Larson Davis cable # CBL035 for longer measurements).
- RS-232 computer interface standard. All functions fully programmable. Comes complete with PC SWW\_SLM\_UTIL software for data retrieval and translate binary files to ASCII format. Other PC software also available.

- Large, two line, 32 character, high contrast LCD display.
- Small [33cm H x 7.5cm W x 2.5cm D (13" x 3" x 1") HWD and lightweight, 370g (13 oz.), including microphone and battery.
- Rugged ABS case with EMI and RFI protection.
- Environmental enclosures available for system security and inclement weather conditions.
- Durable membrane keypad.
- Two-year warranty (see warranty statement on the copyright page at the front of this manual).

## **Model 812 Components**

---

A layout of the Model 812 is shown below:

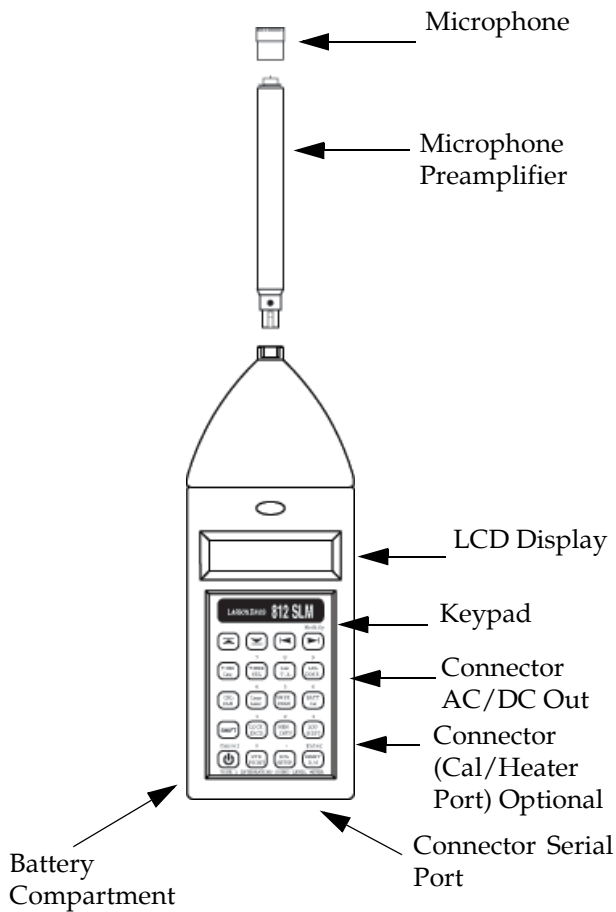

Figure 1-1 *Model 812*. The Model 812 is a convenient hand-held sound level meter with a simple user interface.

As can be seen, the standard Model 812 includes the following:

- Model PRM828 is a 5 1/2 inch precision preamplifier using a standard 5-pin microphone SwitchCraft™ connector and may be extended up to 20 feet with EXCXXX microphone cable. The preamplifier is removed by depressing the small black latch button with a fingertip, while gently pulling it away from the mating connector
- A two-line, 32-character, high-contrast LCD display.
- One of the 1/2 inch precision air condenser microphones in Table 1-8, "Microphones for use with 812". The microphones are rugged and reliable but should be kept in their protective case when not in use. Avoid unnecessary shock (Although a Larson Davis microphone can survive being dropped, it is a delicate, precise transducer that should be handled with care)..

Microphone	Type	Sensitivity mV/Pa	Bias
2540	Free-field	14.5	Voltage Required
2541, 377B41	Free-field	44.5	Voltage Required
377A02	Free-field	50.0	Prepolarized
377A20	Random	50.0	Prepolarized
2559	Random	12.9	Voltage Required
2560, 377A60	Random	45.2	Voltage Required

**Table 1-1** Microphones for use with 812

*Keep clean and protect from  
condensing moisture and water.  
The microphone's ultra-thin*



*diaphragm is covered by a protective grid which should not be removed in normal use. Rain droplets or other foreign matter on the diaphragm may alter the microphones's response. Please use a windscreen whenever possible. Replace the desiccant cartridge when necessary.*

- A 20-key membrane keypad.
- Model 812 precision hand-held Sound Level Meter with integral nose cone. Powered internally by 9 volt cell, or by an external battery or AC/DC adapter.
- WS001 3 1/2 inch windscreen.
- An AC/DC mini phone connector with pinout shown on page 4-10.
- A 5-pin cable connector with the pinout shown in figure Figure 1-2 (Note that this connector is used to access external power):

Using cable CBL038 or INT002 and related software, the 5-pin connector is used both for external power and for the remote interface.

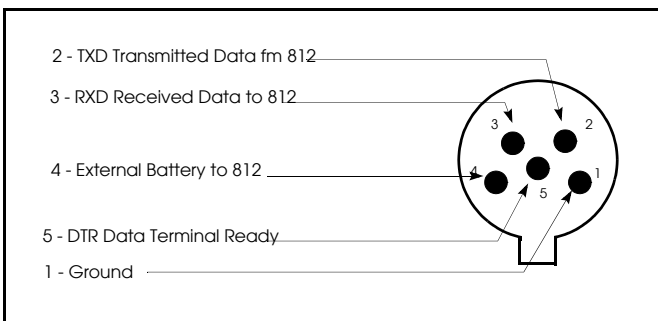

Figure 1-2 **External 5-pin Cable Connector Pinout.**

## Block Diagram

---

All the standard functions of a precision sound level meter are provided: instantaneous level,  $L_{eq}$ , SEL,  $L_{max}$ ,  $L_{min}$ , Dose, projected dose, etc. In addition, many valuable parameters can be stored: time history interval data such as  $L_n$ 's and  $L_{eq}$  etc. Level calibration is performed in a few key strokes, and every change or check is entered in a calibration log.

The Model 812's large data memory relieves the user from the worry of data loss caused by memory limitations. Furthermore, measurements can be printed or transmitted at up to 19.2 K baud via RS-232 for further manipulation or archiving.

Despite its numerous functions, the Model 812 is still extremely easy to use.

Annotated displays indicate units and measurement mode. The single setup menu lets the user scroll through and program parameters or use an index key to modify specific information. Multiple measurement setups can be stored in memory for later recall. And of course, complete setups can also be transferred from a computer.

The block diagram below shows how the Model 812 sound level meter merges state-of-the-art analog circuitry, a powerful microcomputer controller and a large amount of usable data memory.

The signal from the precision air condenser microphone/preamplifier is input directly to the linear peak detector and, through the selected A- or C-weighting filter, to the root-mean-square (rms) and weighted peak detectors. Analog to digital conversion is performed maintaining a full 110 dB range for the RMS signal. The numeric data is then analyzed by the Model 812's dedicated digital processor.

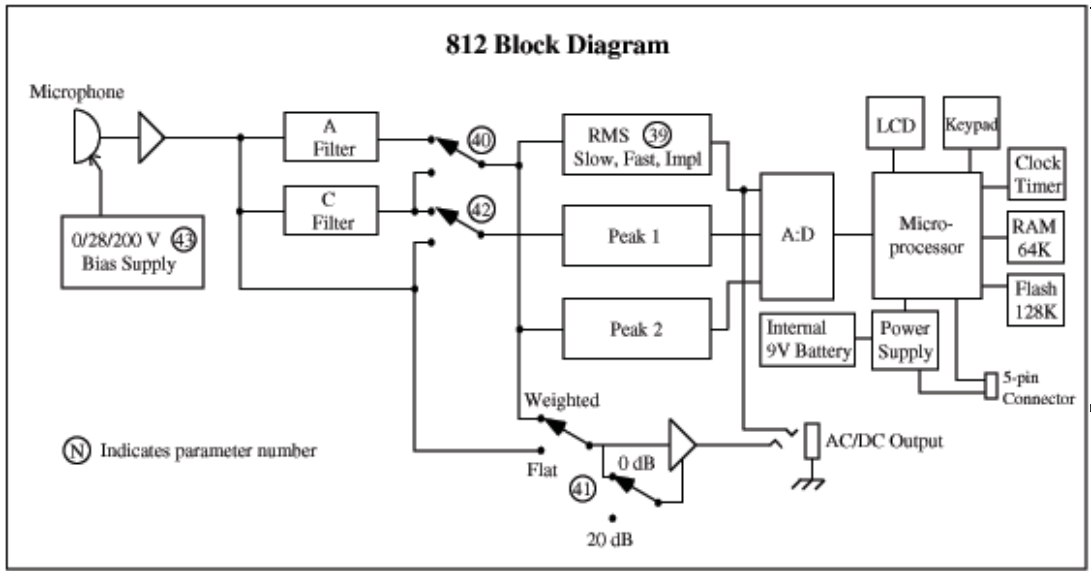

Figure 1-3 **812 Block Diagram**

With system programming residing in Flash ROM (reprogrammable read-only memory), upgrades or future changes in regulations can easily be accommodated. Measurement modes are selected and shown in informative screens on the 32 character liquid crystal display (LCD) . The custom keypad provides direct access to the needed data or setup item. An accurate built-in Quartz clock/calendar and timer are ideal for unattended measurements and time stamping of events.

The 64 KB memory can be used to store time, exceedance or interval data as selected by the user. All can be printed or transferred to an external computer via the serial port, even during data gathering. Larson Davis PC-compatible software employs a binary data dump method for even faster data transfer. External battery or DC power may be supplied through the same five pin connector.

## Getting Started

---

This section outlines the steps you need to follow when you first receive and unpack the Model 812. The following topics are covered:

- Unpacking and Inspection.
- Accessories and Optional Equipment.
- Connecting Internal or External Power.
- Environmental Considerations.
- Preparing to use the Model 812.
- Connecting the Amp/Preamp.

You will then be ready to use the Model 812 for actual measurements (as described later in *Chapter 4* of this manual).

## Unpacking and Inspection

---

Your Model 812 has been shipped in protective packaging. Please verify the package contents with the following list (Accessories and Optional Equipment) and retain the shipping containers for safe shipment at a future date. Report any damage or shortage immediately to Larson Davis, Inc. at (801) 375-0177.

*If you have not already done so, please record, at the beginning of this manual (see the copyright page), your instrument's serial number (located on the label on the back of the Model 812), the microphone serial number (located inside the microphone), the preamp serial number, and the purchase date. You will be asked to give this information in any future communications you may have with Larson Davis, Inc.*

## Accessories

---

The Model 812 is delivered with the following *standard* accessories:

- The standard Model 812 Precision Sound Level Meter including one of the 1/2 inch precision air condenser microphones in Table 1-1, "Microphones for use with 812" on page ' 1- 8 and Model 828 preamplifier.
- Alkaline battery, 9 volts (IEC GLR61 or NEDA/ANSI 1604A).
- User manual.
- Soft carrying case belt pouch (Larson Davis part # CCS009).
- WS001 a 3 1/2 inch windscreen.
- SWW\_SLM\_UTIL software.

*A good quality alkaline cell should provide more than 16 hours of Model 812 operation. Since most rechargeable cells have less capacity, expect shorter use.*

*Wind noise can adversely affect measurements. Using the windscreen on the microphone reduces wind noise and protects the element from dust and bumps.*

*Utility software package allowing data retrieval and translation of*

*binary files, generated by the Model 812, to ASCII File Format via RS-232 connection, and is capable of editing and storing instrument setup parameter to the PC, or loaded directly to sound level meter.*

## Optional Equipment

---

The following optional equipment is also available:

- CBL033: Printer cable for direct printout to serial printer, 6 feet.
- CBL034: Connects Model 812 to bare-ended cable end (4-conductor shielded).
- CBL035: Connects Model 812 and customer supplied external battery.
- CBL042 AC/DC output of the Model 812 to RCA/BNC connectors.
- CBL116 Connects Model 820 to to a PC or a modem. Provides connection for external power adaptor such as PSA017 or similar.
- INT002: RS-232 cable level converter for data transfer to PC. Requires 9 V battery or external AC power supply (PSA001 included). Note that external supply will also power the Model 812.
- EXCXXX: Microphone extension cable, length XXX feet.
- PSA001: AC/DC power adapter, 115 Vac to 9 Vdc, 50-60 Hz for use with INT002.
- CCS002: Custom hard shell, airtight, watertight case (13 1/2 X 12 7/8 X 6 in).
- CBL040: Similar to INT002 but allows one to “daisy chain” an additional Model 812.
- PSA002: AC/DC power adapter, 220 Vac to 9Vdc, 50-60 Hz for use with INT002.
- EPS012: CCS002 weatherproof fiberglass case with custom-cut foam interior and desiccant. Sealed signal cable feedthrough. Features lock hasp and may be chained through handle for security.
- EPS013: Same as EPS012 but with 8 Ah, 12 Volt

rechargeable battery BAT004. Provides 1 week operation in normal conditions. Includes CBL038 and battery charger.

Note Figure 1-4 or call Larson Davis for additional information on these and other accessories.

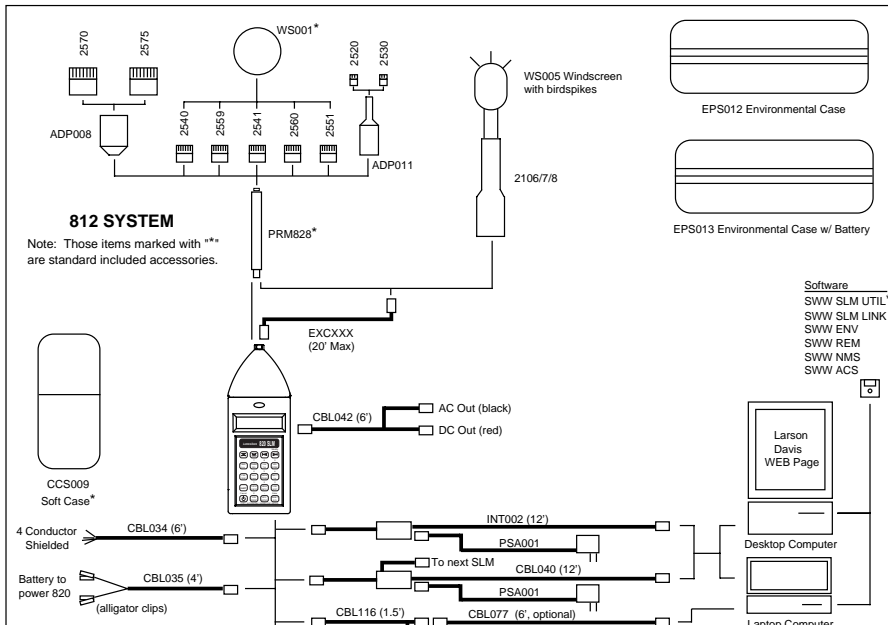

Figure 1-4 System Diagram



## Battery Installation

---

To insert the 9 volt battery in the Model 812, remove the battery cover at the lower left side of the instrument by sliding it out as shown in Figure 1-5



Figure 1-5 *Remove Battery Door*



## Memory Retention

---

Certain safeguards have been included to prevent data loss:

- An internal battery with a full charge will retain memory for 3 months with the instrument off.
- The instrument will turn off when the usable battery capacity drops to 10%. This will leave approximately 1 month of memory retention.

Before turning off, four low battery messages will appear, one every 16 seconds. After 64 seconds the instrument turns itself off.

*Caution: Weak batteries should always be replaced. Discharged batteries will cause memory loss and may leak and damage the Model 812. Always turn the instrument off and disconnect external peripherals before removing the internal battery. Failure to do so may cause data loss. Do not press ON while there is no battery in the SLM.*

- With the battery removed, a capacitor will retain memory for several minutes (during battery change).
- The Model 812 will instantly turn off should the voltage drop to less than about 4.4 V. An error message will be displayed at next power-up: "Warning Power Failure".

Once the battery is installed, the Model 812 is ready for use.

## **Environmental Considerations**

---

The Model 812 sound level meter can be both used and stored in a wide range of temperatures free of moisture and non-condensing humidity conditions. Moisture will cause the breakdown of an air condenser microphone. Some common sense precautions should be taken. For example, allow the Model 812 ample time to adjust to abrupt temperature changes. Condensation may form inside a cold Model 812 if it is brought into a warm room or vehicle and may persist long after the outside case has adjusted to the ambient temperature.

Also, temperatures inside closed vehicles can reach excessive levels. *Therefore, do not leave the instrument in direct sunlight in a vehicle.* A simple safeguard is to keep the instrument inside a sealed foam insulated case or bag with desiccant silica gel, available at photographic equipment stores or from Larson Davis.

## **Preparing to Use the Model 812 - Connecting the Mic/Preamplifier**

---

Before powering the SLM, carefully thread the microphone on the preamplifier. The microphone bias voltage is not dangerous, but installing or removing the microphone with the instrument on may damage the electronics. Insert the 828 in the nose cone or extension cable by lining up the latch button with the channel in the mating connector. The small black dot should click and protrude at the base of the 828 after insertion. It must be depressed completely to remove the preamplifier from

the mating connector.



## *Overview to Model 812*

Once your Model 812 is unpacked and connected to a battery (or external power supply), you can turn it on and take simple measurements. In this chapter, we discuss the following:

- Understanding the Model 812 Keypad.
- Understanding the Model 812 Screen.
- Getting to Know Screen Symbols.
- Turning on the Model 812.
- Checking the Battery Voltage.
- Turning off the Model 812.

## Understanding the Model 812 Keypad

---

The keypad for the Model 812 has 20 keys as seen in the following figure (Figure 2-1):

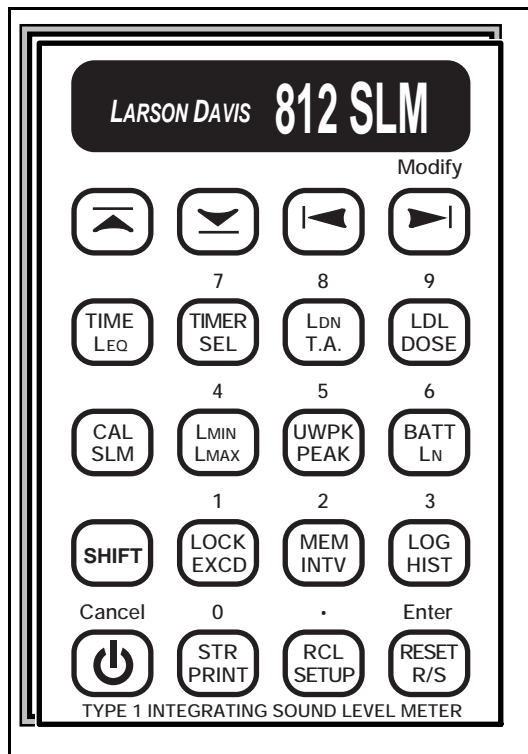









Figure 2-1 **Model 812 Keypad.**









These keys perform the following functions. (This information is covered in more detail in chapter 4, of this manual.)

Keys	Functions
White Orange	White functions are accessed by pushing buttons directly. Orange functions are accessed by first pressing the U key. The smaller letters/numbers above the keys are accessed by the adjoining key at the appropriate time to be explained later.
 	<i>ON</i> Turns on the Model 812. <i>CANCEL</i> : When the Model 812 is on, this button serves to return to a previous menu, or "Cancel" the present function. <i>OFF</i> : SHIFT OFF turns off the Model 812 after it has been stopped.
	<i>PRINT</i> : Access to a list of reports scrolled through the display; a key name is indicated for each one. If there is a "+" following the key name then the options function will be invoked after selecting that key, otherwise the particular report will be printed immediately. <i>STR</i> : A permanent storage register for parameters and calibration data in EEPROM type memory that is not lost when all power is lost. There are 10 RAM registers to store data.
	<i>SETUP</i> : Enables the setting of desired parameters, each accessed by using the up and down arrow keys. <i>RCL</i> : The EEPROM register and the RAM register may be recalled by pressing the RCL key, scrolling to the desired register and pressing ENTER.

Keys	Functions
<p data-bbox="138 210 254 274"><b>RESET</b> <b>R/S</b></p> <p data-bbox="138 288 262 340"><b>Enter</b></p>	<p data-bbox="286 213 749 270"><i>R/S</i>: This key starts and stops measurement.</p> <p data-bbox="286 279 771 401"><i>RESET</i>: Restarts a measurement by erasing the values just measured. This function can be used whether a measurement is in the “run” or “stop” mode.</p> <p data-bbox="286 409 713 466"><i>Enter</i>: used to enter new parameters selected by the user.</p>
<p data-bbox="138 496 237 539"><b>SHIFT</b></p>	<p data-bbox="286 499 771 557"><i>SHIFT</i>: Allows access to the Orange letter functions on the keypad.</p>
	<p data-bbox="286 604 771 795"><i>PASSBY</i>: The PassBy function is a special event detector which measures the <math>L_{max}</math>, <math>L_{eq}</math> and SEL of the highest SPL event making a 10dB or greater SPL excursion. Three additional fields show Duration, Exchange rates, SEL and <math>L_{max}</math>.</p> <p data-bbox="286 803 771 890"><i>LOCK</i>: The lock functions protect instrument data and configuration. The level of security is configured in Setup.</p>
<p data-bbox="138 918 229 982"><b>MEM</b> <b>INTV</b></p>	<p data-bbox="286 921 771 1107"><i>INTV</i>: The Interval History provides a history of a number of statistical values for a moderate size time interval, 1 minute to larger than 99 hours in one minute or greater steps. It is programmed by parameters 72-79.</p> <p data-bbox="286 1116 771 1237"><i>MEM</i>: Memory use in percent, bytes free and total byte available are provided as well as a count of all of the History Records stored in memory.</p>
<p data-bbox="138 1265 229 1329"><b>LOG</b> <b>HIST</b></p>	<p data-bbox="286 1269 771 1454"><i>HIST</i>: The Time History function is a record of short interval <math>L_{eq}</math> reading and optionally, a Peak, UWPK, or <math>L_{max}</math> reading. The interval can vary from 1 second to 255 sec. History period is set by parameters 83-84.</p> <p data-bbox="286 1463 771 1550"><i>LOG</i>: The Run/Stop Log is a time record of all the actions which start or stop the data taking process of the Model 812.</p>

Keys	Functions
	<p><i>CAL</i>: Calibration information and control. Initially, in the CAL-a display, the current calibration offset is displayed with a flashing prompt to press either the UP arrow key to check the calibration or press the d key to change the calibration.</p> <p><i>SLM</i>: The Sound Level Meter function displays the current Sound Pressure Level (SPL) while the instrument is in the Run Mode or the SPL at the instant it was last stopped.</p>
	<p><math>L_{MIN}</math>: The maximum SPL, or <math>L_{max}</math>, is the largest sampled SPL for the overall measurement period, displayed with the date and time of its occurrence. Two additional screens, accessed by pressing the left or right arrows, show the number of times the SPL exceeded two fixed levels.</p> <p><math>L_{MAX}</math>: The minimum SPL, or <math>L_{min}</math>, is the lowest sampled SPL for the overall measurement.</p>
	<p><i>PEAK</i>: The highest weighted Peak Detector output level, <math>L_{pk}</math>. Date and time of the occurrence of the <math>L_{pk}</math> is shown. The number of times the weighted peak level exceeds a programmed threshold is also counted and displayed (-b window).</p> <p><i>UWPK</i>: The highest UnWeighted Peak Detector output level, <math>L_{UWPK}</math>. The date and time of the occurrence of the <math>L_{UWPK}</math> is also shown. The number of times the weighted peak level exceeds a programmed threshold is also counted and displayed (-b window).</p>

Keys	Functions
<p><b>BATT</b> <b>LN</b></p>	<p><i>L<sub>N</sub></i>: The <i>L<sub>n</sub></i> values represent the SPL exceeded n% of the run time. All values from 1% to 99% are available, two of the four are displayed at a time and can be changed even while running.</p> <p><i>BATT</i>: This key gives the percentage of power remaining in the 9 V battery, or external supply.</p> <p><i>BATT-b</i>: Gives Model 812 revision number and date.</p>
<p><b>TIME</b> <b>LEQ</b></p>	<p><i>L<sub>EQ</sub></i>: The Equivalent Level or <i>L<sub>eq</sub></i> is a Time Weighted Average based on an exchange rate of 3dB (true energy measure) with no threshold.</p> <p><i>TIME</i>: The date and time of last reset or measurement start are available from the Time-a display. The current date and time are shown with the Time-b display.</p>
<p><b>C-A</b> <b>SEL</b></p>	<p><i>SEL</i>: The Single Event Level or Sound Exposure Level is an energy reading in decibels. It is the TWA level plus 10 times the log of measurement time in seconds.</p> <p><i>SEL-b</i>: Gives exposure in Pa<sup>2</sup>H which is a linear representation of energy.</p> <p><i>C-A</i>: The C-A function, a hearing protector evaluation, calculates a running C-weighted <i>L<sub>eq</sub></i> and a running A-weighted <i>L<sub>eq</sub></i> in a sequential manner and the difference between them is calculated and shown giving a C-A value.</p>
<p><b>TAKT</b> <b>TWA</b></p>	<p><i>TWA</i>: Time Weighted Average SPL. This display shows the Overall TWA and Run-Time.</p> <p><i>TAKT</i>: The German Takt Maximal Levels, Takt 3 and Takt 5 are an integration of the largest level in a 3 second and 5 second period respectively.</p>



Keys	Functions
	<p><i>DOSE</i>: The Dose and Projected Dose sound exposure percentages are displayed in these screens. Parameters #48-51 control the Dose measurement.</p> <p><i>E</i>: Sound Exposure is a linear energy reading used to assess potential for hearing loss or annoyance.</p>
    	<p><i>Arrows</i>: Up, Down, Left and Right arrows are used to change fields, to modify information within a given field and can be used in conjunction with other keys to allow other functions.</p> <p><i>Modify</i>: Prepares the field for changes while in setup.</p>

## Getting to Know Screen Symbols

---

Symbols basic to the Model 820 are included below. These are generally found to the right of the screen. The Operating Mode Indicator, upper right character, indicates whether data is being accumulated or not and has the modes indicated by the first four examples.

The Keyboard Status Indicator displays which key functions are active. The lower four modes are possible and appear in the lower right corner of the display.

Symbol	Functionality
SSS	(flashing upper case to lower case) Model 812 is stabilizing upon warm-up (10-45 sec.), or SETUP weighting (8s), or bias voltage (30s) change in stop mode.
	Stop mode - no data is being taken.
	Run mode
OV LD	Overload - These letters in succession occur alternately with the stick figure with 8 second intervals when an overload has occurred.

Symbol	Functionality
f	(flashing) - Indicates that the function keys (L <sub>min</sub> , Dose, etc.) are used for different purpose in the current function.
n	Indicates that numeric key input mode is active.
S,2,3	ⓈHIFT key active (secondary function in orange lettering).
SrS	If the Model 812 is still stabilizing upon warmup and the R/S (Run) button is pushed, (r) will flash alternately with (S).

## Understanding the Model 812 Screen

---

The operating screen for the Model 820 has several fields which vary according to the keys pressed on the keypad.

The most pertinent information is generally at the top and center to left and instructions are generally on the bottom center to left. Several characters are consistent in their appearance. We will now turn the Model 820 on and examine a variety of possible screens.

## Turning On the Model 812

---

**Step 1** Press  to power the Model 812 and initiate a self test:

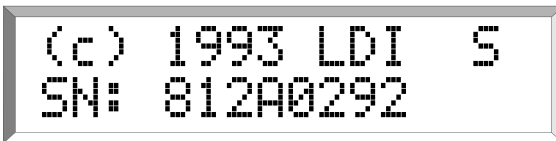

```
(c) 1993 LDI  S
SN: 812A0292
```

*Three successive displays will appear while the meter stabilizes for 10-45 seconds. The first display has copyright information and appears only 1 to 2 seconds.*

*The second display shows the production date and the serial number uniquely assigned to your Model 812. This message appears for only 1 or 2 seconds.*

**Step 2** The third screen automatically appears:

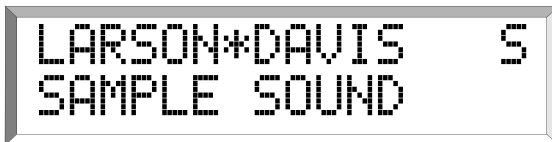

```
LARSON*DAVIS  S
SAMPLE SOUND
```

*This screen will remain until the user inputs other commands. The flashing uppercase (S) indicates system initiation and will continue 10-45 seconds.*



The third screen appears almost immediately showing the title information for the current or last reading and is programmable by the operator.

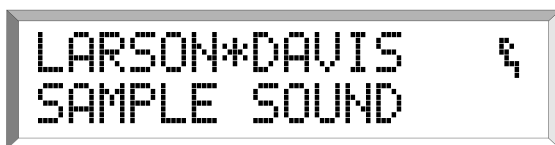

At this point, you can change the parameters and begin taking actual measurements.

When the system initiation is complete, a stick figure in the upper right corner of the display will appear seated indicating the Model 812 is in STOP mode.

## Checking the Battery Voltage

---

The Model 812 continuously monitors its battery voltage to ensure accurate measurements. It has a battery life of about sixteen hours. It will turn off automatically when the voltage falls below 5.7 volts. Therefore you should verify that the remaining battery capacity is sufficient before you make an especially critical or lengthy measurement.

**Step 1** To manually check battery voltage, simply press the **SHIFT** **(BATT/LN)** keys. Information similar to the following will display:

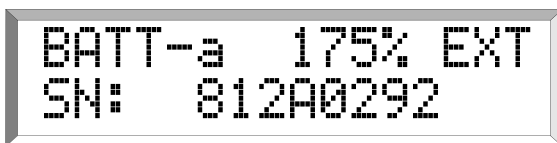
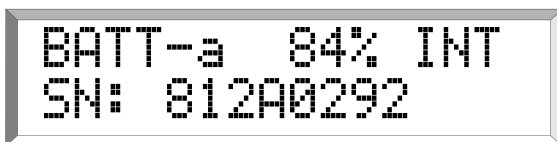

**WARNING!** Do not press the **(BATT/LN)** key during a measurement since it will pause the measurement while pressed.

Remember, pushing a button can produce small low-level noises which can affect your readings. In addition, the Model 812 momentarily pauses the current measurement whenever a key is pressed (in order to interpret the keyboard event). Therefore, where possible, do not press the **(BATT/LN)** key during a valid event you wish to measure.

The first screen shows the percentage of power left in the battery, the internal power source, "INT;" sec-

*ond display indicates external power is being used, "EXTV."*

## Turning Off the Model 812

---

To turn off the Model 812, simply press the **SHIFT** **OFF/ON** key.

*The instrument will not allow itself to be turned off until in (Stop) mode. This feature will insure that no important data is lost.*

## Calibration

Because of variation in microphone sensitivities, a sound level meter must be calibrated to a reference sound level for accurate measurements. This is easily performed with the Model 812. You will need a calibrator with an appropriate adapter for the Model 812 microphone, such as the Larson Davis CAL200. This Larson Davis calibrator outputs 114 dB, or 94 dB, with respect to 20  $\mu$ Pa, and at a frequency of 1000 Hz. At this frequency, the relative response for A and C weightings is the same.

*NOTE: A precision calibrator is not necessary for this part of the tutorial, but you should make it a regular practice to perform an instrument calibration before and after you take actual measurements in the field. However, you do not have to recalibrate the Model 812 when you change the settings.*

Please note that if you use a calibrator which uses another frequency some corrections may be required depending on the weighting. The output level and the frequency of your calibrator should be listed on its label. Use this level with specific environmental and weighting corrections to calibrate the Model 812 level.

In order to perform calibration, the Microphone Polarization Voltage needs to be properly set.

### Calibrating the Model 812

---

Microphone Polarization Voltage is preset by Larson Davis at 200 volts. Should this parameter be incorrect, the Model 812 will not calibrate correctly.

**Step 1** Check the microphone polarization by looking

at setup parameter 43. To do this turn on the Model 812, press **(RCL SETUP)**, **(Modify)**, **4** and **3**, and **(Enter)**. The following display will appear:



Mic Polarization  
[200]

*The flashing (f), the Keyboard Status Indicator, displays which key functions are active. This indicates that the function keys are used for different purpose in current function.*

**Step 2** Should the brackets contain a value other than [200] e.g. [28] or [0], press thr until the value [200] appears, and then press **(Enter)**. If you are using a pre-polarized microphone, this parameter should be set to 0.

*In this screen the value [200] is selected from three options: [200, 28, 0]*

**Step 3** Press **(Cancel)** to return to the main screen:

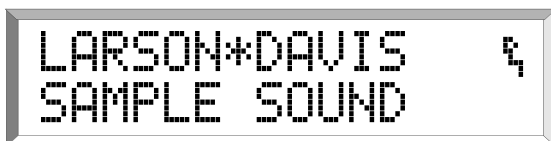

LARSON\*DAVIS  
SAMPLE SOUND

**Step 4** To begin the calibration process, check or insert the new calibration level given in parameter 35. To do this press **(RCL SETUP)**, **(Modify)**, **3** and **5**, then **(Enter)**. The following screen will appear:



CAL Level  
(114.00)

*The Larson-Davis Model CA200 calibrator outputs 114 dB re20  $\mu$ Pa. Note that the Model 812 automatically uses the C-weighting while calibrating. This ensures a correct reading at typical calibration frequencies of 250 Hz to 1 kHz.*

**Step 5** Press **(Modify)**, then enter the “SPL” value of your calibrator (if other than [114.0]), including any corrections for pressure, etc.

**Step 6** The next setup item allows entry of the calibrator serial number, for record keeping purposes. Press the **(↓)**, or **(RCL SETUP)**, **(Modify)**, **(3)** and **(6)**, and **(Enter)**. Press **(Modify)** to change the serial number, enter the correct numbers and press **(Enter)**.

**Step 7** Seat the microphone fully in the calibrator cavity. If possible both units should be at the same temperature and stationary so that hand vibrations are not transmitted to the SLM.

*Refer to the specific instructions accompanying your calibrator for accomplishing this step.*

**Step 8** Press **c** to exit calibration setup. Then, activate the calibrator by pressing the button on its side.

**Step 9** Press the **(SHIFT)** and **(CAL SLM)** on the Model 812. This display indicates the current sensitivity offset and will be blinking between two settings:

*Pressing the **(▲)** will check calibration, pressing the **(▼)** will change it.*



CAL-a Up→Check %  
Offset 6.4dB



CAL-a Dn→Change%  
Offset 6.4dB

**Step 10** Pressing the  key will initiate a calibration change. Do that now:





CAL Chk            0.00  
Stable            114.0



CAL Chk            0.05  
Done            114.0

*In this screen, an error message initially prompted for a reset(see step 12 to reset). The difference between the current and the last calibration is 0 dB. If the level is not stable enough for proper calibration, the Model 812 will exit the calibration mode without changing its calibration level. The "c" indicates the instrument is calibrating.*

*The Model 812 will wait until the reading is stable (indicator is SsSsSs...., then adjust the offset for the proper reading CcCcCc..... An improper calibration offset (for instance, something greater than 39.0dB) may indicate that the calibration tone was shut off before calibration was completed, or that polarization was not properly set. You may repeat the previous steps or perform a Cal check.*

**Step 11** To Reset the Model 812 for re-calibration, press  and .

*The display will ask if you want to "Reset ALL Data?" You do.*

**Step 12** Press . Reset is complete and the instrument will return to the calibration mode.

**Step 13** To leave the calibration mode, press .

## Quick Start

Before running a simple measurement it is important to set a few parameters to meet your needs and become familiar with related functions. In this chapter we will discuss these items:

- Setting parameters using **RCL SETUP**, **(Modify)**, and **(Enter)**
- Using numbers and other characters
- Setting Time, Date, and Day parameters

### Setting Parameters Using Function Keys

---

The Parameter fields can be accessed in several ways:

- By entering numbers assigned to each parameter (the numbers are located above the keys on the keypad and are discussed later in the chapter)
- By scrolling up or down using the u or d keys
- By using any white or Orange function keys

Follow these steps to access the parameters using numeric values:

- Step 1** With the Model 812 on, press **RCL SETUP** and the following screen appears:

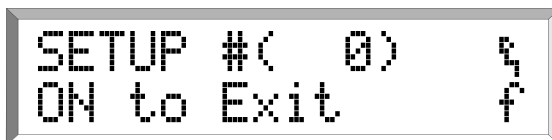

```

SETUP #( 0)
ON to Exit
  
```

*A complete list of parameters and their assigned numbers is found in chapter 8. You have already visited parameter 43, Microphone Polarization, and found it preset to [200].*

**Step 2** To access parameters using numeric values, press **(Modify)**:

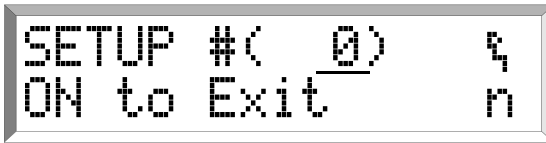

Notice that the flashing (f) has been replaced by a flashing (n) indicating the numeric key access. The flashing parenthesis, indicate this field is ready to receive numeric input.

**Step 3** To access the Current Time, press **0** and then **6**. The number 6 is assigned to the Current Time parameter: and press **(RESET R/S)**

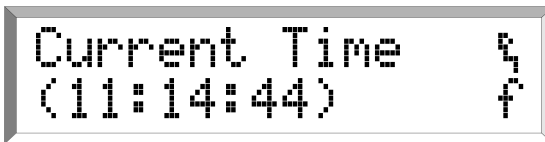

Entering 0 before the new number will remove any prior parameter settings.

**Step 4** Press **(Modify)** to prepare the screen for changes in the Current Time. Notice the flashing (f) changes to (n).

The third way to access Current Time parameter, press **(RCL SETUP)** **(SHIFT)** **(TIME LEG)**. Remember, press m to change or correct the field and press **(Enter)**.



**Step 5** Using numeric keys make changes and press **(Enter)**, or if the time is correct, just press **(Enter)**.

**Step 6** To exit the setup mode, press **(Cancel)**.

## **Setting Parameters Using Numbers and Other Characters**

The Model 812 has the ability to show 3 lines for your Company Name and one line for the Measurement Title which is used on the reports. These parameters are entered from the keyboard.

Through the keyboard, you can enter all of the capital letters from A to Z, the digits 0 to 9, and some punctuation characters. There are three levels of **(SHIFT)** functions when in the "Alpha Parameter Modify Mode."

The charts below, (Figures 4-1 to 4-4), show the characters that are available. They are listed according to the number of times you consecutively press the **(SHIFT)** key. The shift indicator in the lower right corner of the instrument's display will show the number of times the **(SHIFT)** key has been pressed by showing the letter n and S, then 2 and 3 respectively for 0 to 3 presses.

*This panel is available without pressing the shift key, or the equivalent of 0 presses.*

↑	↓	←	→
+	7	8	9
-	4	5	6
SHIFT	1	2	3
CANCEL	0	.	ENTER

Figure 4-1 **Standard Alpha-Numeric Keyboard Layout**

%	*	↵	↳
A	B	C	D
E	F	G	H
SHIFT	I	J	K
CANCEL	L	M	ENTER

Figure 4-2 **S Shift Level-1 Alpha Numeric Keyboard**

*This panel is accessed by pressing the shift key one time. The (S) will appear in the lower right corner of the display indicating this panel is accessed.*

;	=	CLEAR	SPACE
N	O	P	Q
R	S	T	U
SHIFT	V	W	X
CANCEL	Y	Z	ENTER

Figure 4-3 **2 Shift Level - 2 Alpha-Numeric Keyboard**

*This panel is accessed by pressing the shift key two times. The number (2) appears in the lower right corner of the display indicating this panel is accessed.*

&	@	\$	\
!	?	<	>
^	/	(	)
SHIFT	'	“	:
CANCEL	#	,	ENTER

Figure 4-4 **3 Shift Level - 3 Alpha-numeric Keyboard**

*This final panel is accessed by pressing the shift key three times. The number (3) appears in the lower right corner of the display indicating this panel is accessed.*

**Step 1** Turn the Model 812 on and press these keys:

**RCL** **SETUP** **Modify** 0 2 **Enter** :



All but the last of these screens you have seen before. This display is to set one of four custom instrument name screens which will appear each time you turn the instrument on.

**Step 2** Press **Modify** .

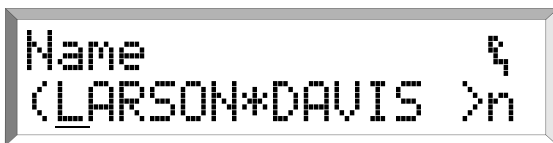

Notice the parentheses begin to flash and the (f) changes to (n) and the (L) is underscored (Larson-Davis). You may now enter the appropriate letters here by using the "Alpha Character Keyboard Entry" shown above.

**Step 3** Press **SHIFT** three times:

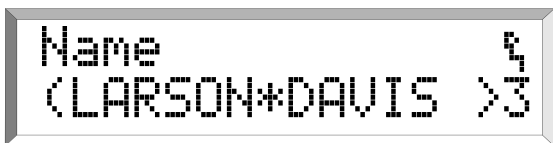

The flashing (n) is replaced by (S), (2), and (3) respectively, and will remain for five seconds. At this time you may select any character from the S, 2, or 3-tables, press that key and it will replace the letter at the cursor ( ). The cursor then moves to the next letter

Example: To enter the company name of **Larson Davis** in the first line, follow these steps:

**Step 1** To access the Name Display turn on the meter. Press **RCL** **SETUP** **Modify** 0 2 **Enter** .

The display in Step 1 above will appear.

**Step 2** Press **Modify** to place the cursor at the beginning or use the **◀** or **▶** to position the cursor.

**Step 3** To clear the field, if necessary, press **SHIFT** twice and the **◀** key.

If you change your mind about clearing the field, hit c to return to the original title. Repeat a and b in Step 5 to return to this point.

**Step 4** The letter (L) is on the S-field. Press **SHIFT** .

Enter the **(LOCK EXCD)** key, second from the lower left. The cursor will automatically move to the next letter.

- Step 5** The letter (A) is on the S-field. Press **(SHIFT)** again. *Enter the (A) key.*
- Step 6** The **(RCL SETUP)**, **(RESET R/S)**, **(OFF ON)** keys are in the 2-field. Press **(SHIFT)** twice to access the 2-field. *Enter the **(RCL SETUP)**, **(RESET R/S)**, **(OFF ON)** keys consecutively or one at a time.*
- Step 7** To Clear the field, press **(SHIFT)** twice to access the 2-chart and press the Clear key.
- Step 8** To replace a character with a Space, press **(SHIFT)** twice to access the 2-field and press the Space key. *Complete the rest of the entries in the same fashion.*
- Step 9** When the first line is completed press the **(▼)** to go to the next field, the second line.
- Step 10** Press **(Modify)** and select the appropriate chart by pressing **(SHIFT)** and the desired character key. *Three lines are available for entry, i.e. company address, telephone.*
- Step 11** When the second line is complete, press the **(▼)** to go to the next field, the third line, and repeat the process.
- Step 12** The fourth line is for the Measurement Title. Press the **(▼)** key. *The first and fourth lines will appear on screen when the Model 812 is turned on.*
- Step 13** To exit the setup mode, press **(Cancel)**.

## Setting Time, Date, and Day parameters

---

Once you have set the parameters, you can now enter the correct time and date. The Model 812 has a 24 hour (military time) clock where afternoon hours are denoted by adding 12 hours, e.g. 3:45 pm = 15:45 hrs. Modify this parameter as follows:

- Step 1** With the Model 812 on, press **(RCL SETUP)** **(SHIFT)** **(TIME LEG)**: *The current time is displayed. If it is incorrect, enter the correct time.*



Current Time      &#9632;  
(hh:mm:ss)      n

**Step 2** Press the mkey and use the numeric keys to enter correct time and then press **Enter**.

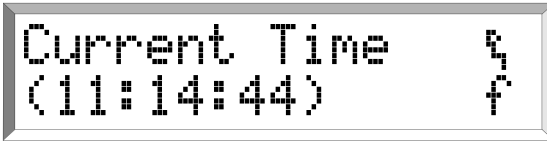

**Step 3** The Current Date is the next field. Press the **Down Arrow** to the next display:



**Step 4** The Day of the Week is in the next field. Press **Down Arrow** to access that field.

*The current date will appear. If it is incorrect press m to access the field, enter the correct date using the corresponding number keys and press e.*

*If the day is incorrect press m and r or 1 to the correct day. Press **Enter**.*

*To exit the setup mode, press **Cancel**.*

## AC/DC Output

---

AC and DC is accessed by the use of the optional CBL042 or by using a stereo miniphone plug as shown in figure 4-5. The DC output provides a voltage from the RMS detector that is proportional to the sound level. The scale is 20.3 mV/dB. The output voltage is 0-3 volts with an output impedance of 600 $\Omega$ . The AC output gives an AC signal proportional to input signal and can be Flat or A and C weighted. It is used to record input signal to the Model 812 (see Appendix A for more details).

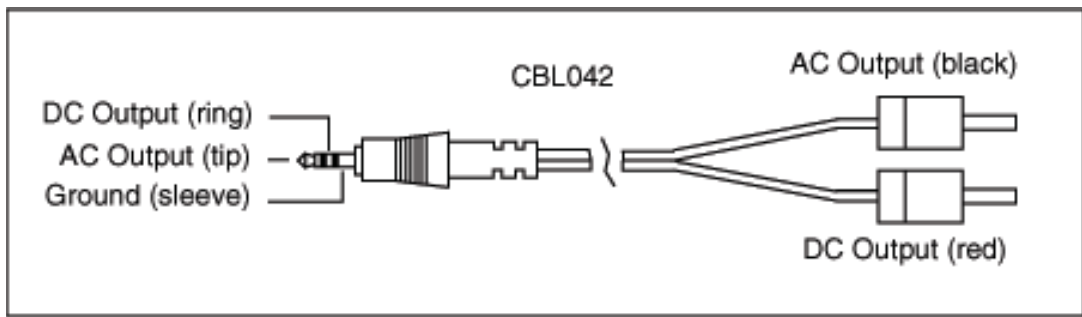









Figure 4-5 *AC/DC Output Connector*

# *Performing a Measurement/ Reading the Data*

With the basic parameters set and the instrument calibrated (as discussed in Chapters 3 and 4), you are ready to take a measurement and examine the readings from the data collected.

Taking an actual measurement with the Model 812 only requires pressing the  or RUN/STOP key.

In this chapter we will:

- Take a measurement.
- Examine and briefly explain the function keys associated with the measurement, i.e.      
  and .
- Stopping the measurement.

## **Taking a Measurement**

---

This section will address measurements and the information available during and after the measurement has been taken. The most basic function of the Model 812 is to measure sound pressure. Follow these steps to examine the SLM function key:

### **SLM**

---

**Step 1** Turn the Model 812 on and wait for the unit to

become stable. Press . The stick figure in the upper right corner will appear to be running.

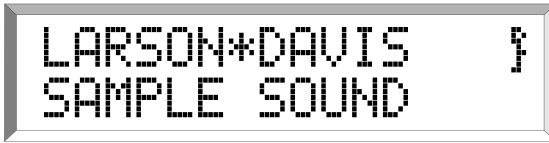

**Step 2** With the instrument in RUN mode, press . The current sound pressure level is displayed:

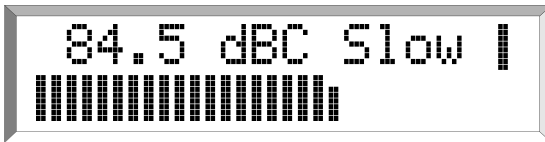

**Step 3** An additional six screens are available from this display. Press the  key to access the first:



- a. Parameter 61: RMS Exceedance.
- b. Parameter 62: RMS Exceedance 2.
- c. Parameter 63: Peak Exceedance.
- d. Parameter 64: UWPK Exceedance.
- e. Parameter 112: Overload (current).
- f. Parameter 160: O.OVL D (overall overload).

*This instrument can store a great variety of measurements in memory depending on the current parameter setup. Nevertheless, current measurements are always easily available from the keypad.*

*The display now reads an C-weighted, slow average reading of 84.5 dBC (re 20  $\mu$ Pa). The level is also shown on a semi-analog bar graph. Parameters 39-43 affect these values and parameters 45-47 effect the Current SLM.*

*The  $L_{min}$  and  $L_{max}$  for the current reading at the current time are displayed in the first screen. Notice that the current sound pressure level continues to read in the upper left corner and fluctuates. Note that even in the stop mode the Model 812 continues to monitor SPL while in this window.*

*Notice the space beneath "88.4" in this screen. The "\*\*\*\*" are in an area where six fields of information are available. Respectively, with the controlling parameter, these are listed to the left. If these parameter values have been triggered, the "\*" will appear to indicate that the record contains information related to that occurrence.*



These values may be checked at any time while the measurement is being taken, or final readings after the measurement has been completed. Be careful not to bump or drop the instrument as the results of the reading will be affected.

**Step 4** Press the  key again for the second screen. In this example the measurement is running. Notice the figure is in motion:

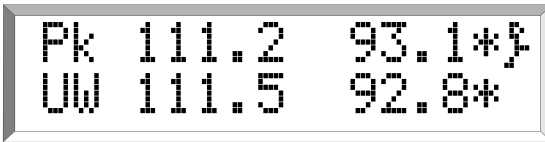

*The Peak and Unweighted Peak are displayed here. Note that even in the stop mode, the Model 812 continues to display the detected values on the upper right hand side of the screen.*

*The numbers on the left are the highest during the measurement and the values on the right are the current Peak and Unweighted Peak.*

**Step 5** Press the  key for the third screen:

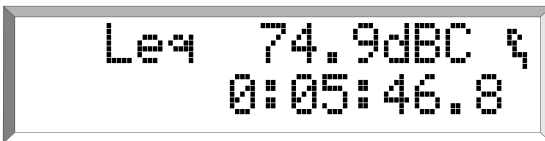

*The  $L_{eq}$  values are shown here to be 74.9 dB, C-weighted, the measurement ran for 5 minutes 46.8 seconds. Should an Overload occur, one of four letters (OVL) would flash alternately with the stick figure in the upper right corner (see Chapter 7).*

**Step 6** Press the  key for the fourth screen:

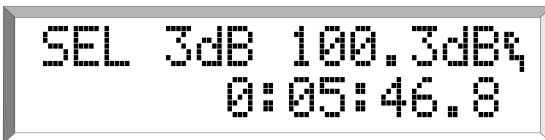

*The SEL level (using 3dB exchange rate) is 100.3 dB and the duration of the measurement is given.*

**Step 7** The next screen addresses the Alarm time and current temperature. Press the  key and the fifth screen will appear:







*The Alarm can be set to begin a measurement at a designated time. The "??:??" here indicates the next measurement has not been chosen. The current internal temperature as measured by the Model 812 is shown in the lower portion of the screen.*

**Step 8** The property controlling the final screen in this series is built into the Model 812 to conserve power. Press the  key.





Pressing the  key again will scroll loop you back to the SLM original screen.

Now that you are more familiar with the information available in the displays above, lets take a closer look at the parameters that affect these readings.

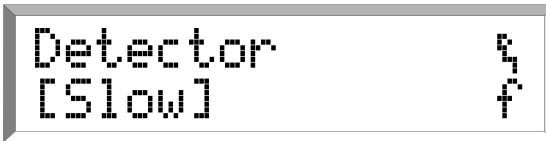
**Step 1** To access these parameters turn the Model 812 on by pressing **Cancel**. Next press  **Modify**   **Enter** (Or press , ), and the following screen will appear:



**Step 2** The Detector prompt has three possibilities indicated above. Press **Modify**  to access desired setting, and **Enter**

**Step 3** To set the *Frequency Weighting*, press  to item 40. There are several possibilities here:

[A, A16, C, C16, Flt]

*The Model 812 has been programmed to save power whenever it can. Each time input is made the internal timer will start at 100 and count downward. If not programmed to do otherwise, the Model 812 will turn itself off when this screen reaches 0, just over two minutes.*

*Slow: exponential avg.: 1 second constant.  
Fast: exponential avg.: 1/8 second constant.  
Impl: impulse response.*

*For OSHA measurements, this is normally set to Slow. For environmental measurements, Fast or Slow may be used. Within a given period of time, the Fast detector will take more measurements than the Slow. Therefore, the Fast detector is likely to measure more higher and lower levels than the Slow detector.*

*The A and C weightings simulate human hearing response and meet Type 1 precision standards for accuracy. Flat (no weighting) allows the signal to pass through unfiltered (A16, C16 and Flat do not apply to the Model 812).*

**Step 4** The Model 812 has been preset at [A]. To change the setting press **(Modify)** **(▶)** to the preferred setting and **(Enter)**.

**Step 5** Find item 41 by pressing **(▼)**, *AC Out Weighting*, which has the values listed here. Choose one by pressing **(▶)**. [Flat, Whgt, F+20, W+20]

*F+20 means Flat plus 20 dB of level added.*

*W+20 means Weighted with 20 dB of level added.*

**Step 6** Item 42, *UwPk Weighting*, press the **(▼)** key again. Chose from the values listed with **(▶)** **(▶)** [Flat, C]

*Flat record all sound and C weighting simulates the human hearing at higher sound levels.*

**Step 7** Item 43, *Mic Polarization*, was touched upon earlier.

*This selects the polarization voltage for the microphone. Choose 28 or 200 V (typically 200 V is chosen) for condenser type microphones and 0 V for pre-polarized microphones (electret).*

**Step 8** Item 44, the *Reference Level*. All measurements are offset by this dB reference level, normally set at 114.0 dB or 94.0 dB.

**Step 9** Press **Cancel** to exit setup mode.

## L<sub>max</sub>-L<sub>min</sub>

---

We have already looked at the L<sub>max</sub> and L<sub>min</sub> in a previous screen. These values are also available directly from display keys. They can be accessed while the unit is taking a measurement or in the stop mode. Only when the unit is running is the data recorded. These measurements are usually read after they have been taken and the measurement is stopped. Here we will examine them while a measurement is being taken:

**Step 1** Press **L<sub>MIN</sub>** to display the greatest RMS SPL value since the beginning of the measurement:

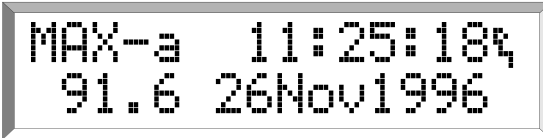

MAX-a 11:25:18  
91.6 26Nov1996

*The highest RMS level occurred at 11:25 hrs., and was 91.6 dBA on the given date. Additional screens are available here recording the number of times the current reading has reached predetermined levels (selected in parameters 61-62).*

**Step 2** Press the **▶** key and examine the second screen available in this series:



MAX-b => 55dBC  
13 times

*In this example, parameter 61 was set to 55 dB and C-weighted (parameter 40). In this measurement the RMS has topped this level 13 times.*

**Step 3** Press the **▶** key to find the third screen:



MAX-c => 65dBC  
9 times

*The display shows that parameter 62 was set to (65 dB) and is C-weighted. This measurement topped this level 9 times.*

The same key,  $\text{L}_{\text{MIN}}$ , finds the  $L_{\text{min}}$  values in conjunction with the  $\text{SHIFT}$  key.

**Step 1** Examine these values; press  $\text{SHIFT}$   $\text{L}_{\text{MIN}}$  and the following display will appear:

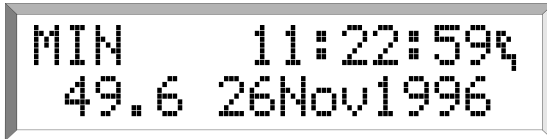

MIN 11:22:59  
49.6 26Nov1996

The current measurement  $L_{\text{min}}$  occurred on November 1, 1996, at 11:22 hrs. (Remember, the Model 812 used military time to designate between A.M. and P.M.) That  $L_{\text{min}}$  value was 49.6 dB.

There are no other screens available from this display.

## PEAK-UWPK

---

The Model 812 also has a peak level detector. Its values during the measurement (or when stopped) are found by pressing the  $\text{UWPK}$  key.

**Step 1** Access Peak values. Press  $\text{UWPK}$ :

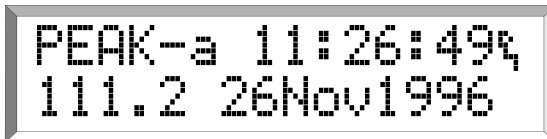

PEAK-a 11:26:49  
111.2 26Nov1996

PEAK is a weighted value and represents a true Peak SPL from the on-board Peak Detector. In this example the PEAK is 111.2 dB and occurred at the time and date shown on the screen. Parameter 63 sets the level above which the readings must go to be recorded by the Model 812.

**Step 2** The second display available from this function is accessed by pressing the  $\text{▶}$  key:



PEAK-b => 74dBC  
156 times

Parameter 63 controls the setting for this measurement. Here the setting is 74 dB, C-weighted and in this measurement was equal to or exceeded 156 times.

Unweighted Peak (UWPK) has two screens available as well and are accessed with the  $\text{SHIFT}$  and  $\text{UWPK}$  keys.

The unweighted Peak value is the unfiltered (no A or C weighting) signal from the Peak Detector).

**Step 1** Press **(SHIFT)** and **(UWPK PEAK)** and examine these values for the current reading:

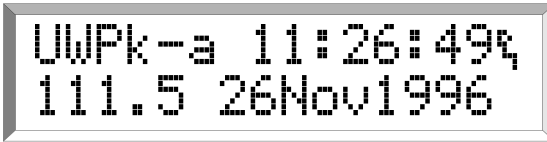

UWPk-a 11:26:49%  
111.5 26Nov1996

**Step 2** For the second screen, press the **(▶)** key:



UWPk-b => 85dB%  
161 times

*The value for the UWPk is set in parameter 64 and is 85 dB. This value was reached 161 times.*

## L<sub>n</sub>

---

L<sub>n</sub> values are determined by parameters 55-60 and should be examined next in our current measurement.

**Step 1** Access L<sub>n</sub> by pressing the **(BATT L<sub>n</sub>)** key and a screen similar to the following will appear:

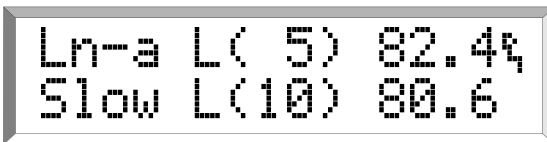

Ln-a L( 5) 82.4%  
Slow L(10) 80.6

*Parameters 55-56 in this example were set to 5 and 10 respectively. This screen shows their values in this measurement. These indicate the sound pressure levels that were exceeded 5 and 10% of the measurement duration.*

**Step 2** Press the **(▶)** key to access the second screen:

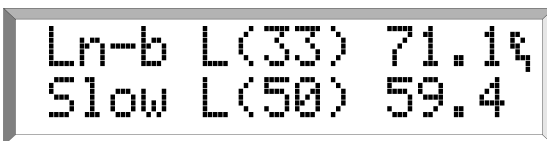

Ln-b L(33) 71.1%  
Slow L(50) 59.4

*Parameters 57-58 were set at the given values shown in the screen and their readings are apparent.*

## L<sub>eq</sub>

---

The average RMS level, the L<sub>eq</sub>, is displayed by pressing

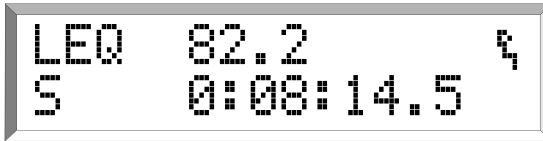

*The average RMS level in this reading is 82.2 dB, slow, average for the 8 minute and 14.5 second measurement period.*

## Dose

---

DOSE, the noise exposure, may be calculated with two different sets of parameters:

- Current.
- Overall.

Parameters 45-51 are used with the calculation to arrive at the current dose from the current data and sets the exchange rate, threshold level, and criteria level for the current measurement. These can be set differently from the overall in order to give different dose readings.

To protect the measurement, the OVERALL Dose settings (parameters 48-50) may not be modified once the measurement has started without a reset. However, OVERALL CRITERION may be changed at any time.

*Parameter 51, Full Dose Period (or Criterion Time) applies to Current Overall.*

A new measurement may be started at any time without effecting the Overall Dose using the Current Dose settings by modifying the CURRENT exchange rate and threshold settings. An automatic reset occurs when CURRENT settings are modified creating a new CURRENT dose measurement based on data collected from that time on.

Before we continue with our present measurement, take a minute to examine the parameter values available, all of which will effect the measurement.

The *Current Exchange Rate* parameter, item 45, is accessed by the following steps:

**Step 1** Press **OFF ON**, **RCL SETUP**, **4** and **5**, then **Enter**. The choices here are listed below:

[3dB, 4dB, 5dB, 6dB]



*The appropriate value for this parameter is established by enforcement authorities in various countries. In the USA, OSHA mandates a 5 dB exchange rate. 3 dB is common in most other countries.*

*Note that these can be changed without a (reset-all).*

The *Current Threshold*, item 46, has a range from 0 to 255 dB.

**Step 2** Press the **▼** key and choose the desired dB level for the Current Threshold. Larson Davis has preset this parameter to 80 dB.

*The normal Dose setting for threshold is 80 dB which allows the instrument to virtually ignore sound below that level as it does not contribute significantly to the weight of the measurement data sought, and saves memory as well.*



**Step 3** If you wish to change this level press **(Modify)**, enter the desired dB numerically and press **(Enter)**.

The *Current Criterion* is the next parameter, item 47, and has been preset to 90 dB in a range of 0 to 255 dB.

**Step 4** Press the **(v)** key, item 47. Press **(Enter)** if you wish to keep the 90 dB level, or press **(Modify)**, enter the desired dB numerically and press **(Enter)**.

*Damage to hearing normally occurs with lengthy exposure to sound at 90 dB and above. For this reason the Criterion is generally set at 90 dB.*

The *Current Dose* is often used as a second Dose measurement. The collected data is available on the printout.

The *Overall Dose* parameters have the same available settings as the current settings and are accessed in the same way.

**Step 5** To access items 48-50, *Overall Exchange Rate, Overall Threshold, Overall Criterion*, press the **(v)** key.

*Changes can be made in any display by pressing **(Modify)**, entering desired values, and pressing **(Enter)**.*

*Full Dose Hours*, item 51, has a range of 0 to 99 hours but is normally set to an 8 hour workday.

**Step 6** To access Full Dose Hours press the **(v)** key.

*The overall criterion level set in item 50 and the dose hours set in item 51 determine what is 100% dose.*

**Step 7** To look at DOSE, press **(LDL DOSE)**.



**Step 8** To look at Projected Dose, press **(▶)** to the PROJ-b screen.

*This step will not work while in the SETUP mode.*

**Step 9** To look at Sound Exposure, **(LDL DOSE)**, press **(SHIFT)** and .

*This step will not work while in the SETUP mode either.*

Dose readings are usually read and have more meaning after the measurement is completed. Returning to our recent measurement, let's examine the  key and look at the values recorded there:

**Step 1** Press the  key where two screens are available. Press the  key to access the second screen:



DOSE-a 0.08%  
S 0:06:14.2

*The measurement ran for 6 hours, 14 minutes, and the dose was 0.08%.*



PROJ-b 6.14%  
S 0:06:57.7

*The Projected Dose extrapolates the eight hour dose from dose A which is the current measured dose.*

The Exposure reading is displayed on the next screen. We will visit this screen using the following steps:

**Step 1** Press the  and keys:

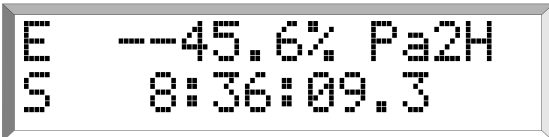

E --45.6% Pa2H  
S 8:36:09.3

*Notice in this reading the Pa2H value is given, along with the measurement time.*

The TAKT is the final function we will consider in this area. This function gives Takt 3 and Takt 5 levels which are an integration of the largest level in a 3 second and a 5 second period respectively.

**Step 2** Access TAKT by pressing  and .

*The measurement is C-weighted and the values as indicated.*

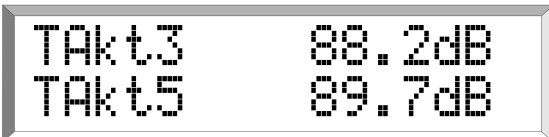

TAKt3 88.2dB  
TAKt5 89.7dB

## BATTERY

---

In Chapter 2 we accessed the Battery information to check the amount or voltage remaining in our battery. This function has additional screens available. The first two indicate the amount of voltage remaining and the second shows the information related to the last revision.

**Step 1** Access the Battery display by pressing **(SHIFT)** and **(BATT LN)**. Press the **(▶)** key to access the second screen:

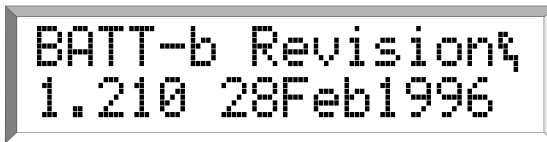

BATT-b Revision%  
1.210 28Feb1996

**Step 2** Press the **(▼)** key and a screen similar to the following will appear:

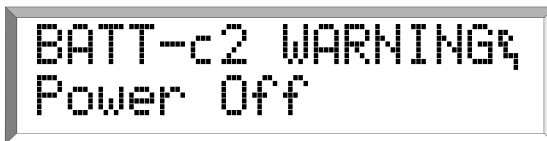

BATT-c2 WARNING%  
Power Off

*The Revision date is shown.*

Eight additional screens are available from this function. Warning or Error messages encountered during normal operation will be displayed here in the order they happen. They are accessed by either the **(◀)** and **(▶)** keys, or the **(▲)** and **(▼)** keys which will scroll only the warning messages.

## MEMORY

---

Memory will be addressed in Chapter 9, but it would be well to examine the  key functions here. Standard memory size is 64 KBytes. Three screens are available from this function.

**Step 1** Press  and . A screen similar to the following will appear:

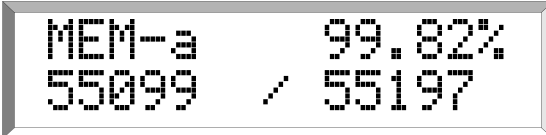

```
MEM-a      99.82%
55099     / 55197
```

*This screen shows the percentage of memory left of the total available.*

*55099 divided by 55197= 99.82%*

**Step 2** Press the  key to access the next screen:



```
MEM-b      Ex      37%
Iv         4 Dy         1
```

*Total Exceedances were 37 total Intervals were 4, and 1 Daily Histories.*

**Step 3** The third screen gives additional information. Press the  key to examine this screen:



```
MEM-c      Hs      18%
Lg         8 CL         0
```

*This display indicates there are 18 Histories in memory, 8 Logs and 0 Calibrations. Hs is the number of time history samples. Lg is the number of RUN/STOPS made, and CL is the number of calibration check records.*

## Stopping the Measurement

---

Press  to stop the measurement. The stick figure will resume the resting position. To view any of the previous measurement data simply press the appropriate key and the information will appear.

## Timed Measurement

The ability to take a measurement at a specific time and date is one of the unique qualities of the Model 812. This feature allows you to take unattended measurements. Accessed through the *TIMER* key, this flexible system has modes to permit one or two measurements a day between two dates, or, a single block measurement from a start date and time to a stop date and time.



In this chapter we will discuss:

- Using the Timer for Unattended Readings.
- Using the Time Key Functions.
- Setting the Password Lock to Protect Settings.

### Using the Timer for Unattended Readings.

---

Examine the timer capabilities by looking at the parameter fields:

**Step 1** Turn the Model 812 on, press  followed by , **2**, and **1**. The following display will appear:

*The Timer parameters, 21-27 begin with this screen, parameter 21.*

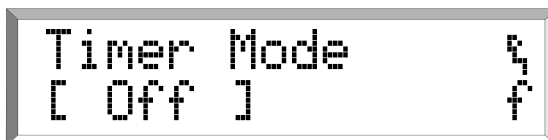

```

Timer Mode      f
[ Off ]        f
  
```

**Step 2** Press **(Modify)** to access the cursor in brackets. With the brackets flashing use the **(▶)** to select one of four possibilities:

[Off, Block, 1/Day, or 2/Day].

*Block: Run Time 1 on Run Date to Stop Time 1 on Stop Date.*

*1/Day: Run Time 1 to Stop Time 1 each day from Run Date to Stop Date.*

*2/Day: Run Time 1 to Stop Time 1 and Run Time 2 to Stop Time 2 each day from Run Date to Stop Date.*

Example: Suppose we want to measure a given area near a large machine in a factory for 5 days, 2 periods each day.

**Step 3** To do this, choose [2/Day] and press **(Enter)**.



Timer Mode            &  
[2/Day]                n

**Step 4** To continue, press the **(▼)** to access the next parameter screen, item 22.



Timer Run Date &  
(26Sep1996)

To continue our example, we want to start 26 September at 8:30 A.M. and end at 12:00 noon, begin again at 1:00 P.M. and end at 4:30 P.M. each day for 5 days.

**Step 5** Press **(Modify)** to change the date and enter 09 26 96. Press **(Enter)**. The new *Timer Run Date* is now 26 Sep 1996.

*If the date is incorrect, simply press m and enter the correct data, then press e.*

**Step 6** To access Timer Stop, press the . A Previously entered date will appear.

**Step 7** To change the date, press **(Modify)** and enter the **(5)** day ending date, i.e. first of October, i.e. 01 10 96 **(Enter)** and the following display will appear.

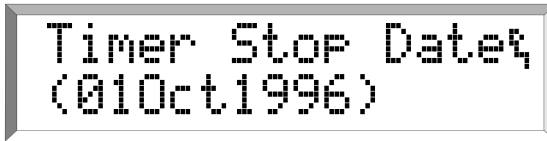

The LCD display shows the text "Timer Stop Date" on the top line and "(01Oct1996)" on the bottom line. The text is in a monospaced font and is centered within a rectangular frame.

The five day block is now set. Next we will set the time periods each day within the block.

**Step 8** Press the  to *Run Time 1*, and press **(Modify)**. Our start up time is 8:30 A.M. so press 08 30 and **(Enter)**, and the display should look like this:



The LCD display shows the text "Run Time 1" on the top line and "(08:30)" on the bottom line. The text is in a monospaced font and is centered within a rectangular frame.

**Step 9** Press the  to *Stop Time 1*. Press m to enter the numbers 12 00, and then press **(Enter)**:



The LCD display shows the text "Stop Time 1" on the top line and "(12:00)" on the bottom line. The text is in a monospaced font and is centered within a rectangular frame.

**Step 10** Press the  to *Run Time 2*. Press **(Modify)** to enter 13 00, our afternoon start time. Press **(Enter)**.



*Notice that military time is used (0:01-24:00) to avoid confusion A.M. to P.M.*

**Step 11** Press the  to *Stop Time 2*. Press **Modify** to enter 16 30 and **Enter**.

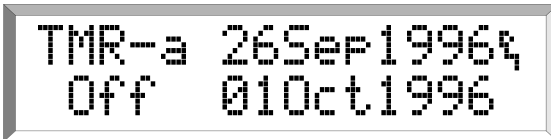
**Step 12** To check your *Timer* setup, press **Cancel**. This will return you to the main screen. Press **SHIFT**  and the following screen should appear:



```
TMR-a 26Sep1996
Off 01Oct1996
```

**Step 13** If you press the  key, it will give you the morning time run. If you press the  again it will give you the afternoon time run settings:



```
TMR-b 08:30
#1 12:00
```

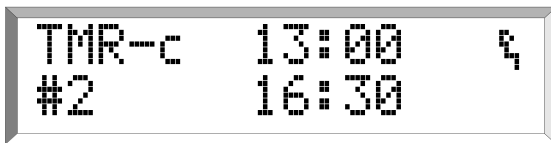

```
TMR-c 13:00
#2 16:30
```

*The Model 812 can now be turned off by pressing UO and placed in the test area. Make sure to check the battery (Chapter 2) or connect to external power. Also consider the safety of the instrument during the test period. Finally, verify that the current time and date are set correctly in the internal clock of the 812. The following section covers setting the time and date. The Model 812 will turn itself on and begin measurement at the appropriate time.*



## Using the Time Key Functions

---

In Chapter 5 we learned to take a measurement and examine some of the data gathered during that reading. The TIME key functions as a record of when the last measurement started. Two screens are available in this function.

**Step 1** Press **SHIFT** and **TIME** to access this information:

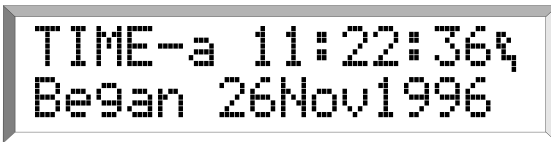

TIME-a 11:22:36  
Began 26Nov1996

Current time, day, and day of week are controlled by parameter 6-8.

*This screen displays the time and date the current or last measurement began.*

**Step 2** Press the **▶** key to access the second screen:

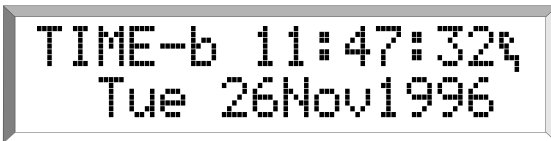

TIME-b 11:47:32  
Tue 26Nov1996

*The second display shows the current date, day, and time.*

**Step 3** Press **Cancel** to return to the main screen.

## Setting the Password Lock to Secure Settings

---

The Model 812 SLM can insure that your settings will not be disturbed by providing a Lock Password parameter (items 28-29).

**Step 1** From the previous field press **▼**, or from the main screen, press **RCL SETUP** **Modify** **2** **8** **Enter**. You can also press **RCL SETUP**, **SHIFT**, **LOCK EXCD**:

*Refer to Chapter 4 to review entering numbers or letters by using the **SHIFT** key.*

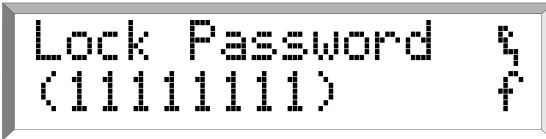

Lock Password f  
(11111111) f

**Step 2** Press **Modify** and enter your personal combination of numbers or letters from 1-8 characters.

*If you choose to use this feature, enter something you won't forget i.e. a name or birth year, and press **Enter**.*

**Step 3** To turn on the *Lock*, press the **▼**, **Modify** and **►** keys. When [Yes] appears, press **Enter**.

**Step 4** If you should wish to unlock the system for further input or readings, press **SHIFT** and **LOCK EXCD**, then **Modify**.

*Notice that as you enter your code only (\*\*\*\*\*) appear to protect your password. Again, make the password easy to remember should you wish to use this function.*

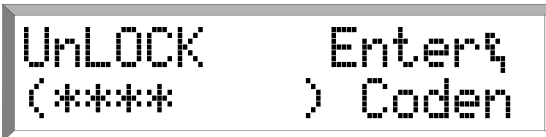

UNLOCK Enter f  
(\*\*\*\*\*) Coden

*Enter your password code and press **Enter** The Model 812 is now unlocked and accessible for additional entries.*

# History Functions

The process of measuring and recording units of sound and retrieving the data for study and understanding is enhanced by additional functional capabilities of the Model 812 Sound Level Meter.

This chapter will cover:

- Setting and Viewing Advanced Functions
  - Time History and Data
  - Log and Data
  - Interval History
  - Interval History Data
  - PassBy functions
- Dealing with OVERLOAD.

## Setting and Viewing Advanced Functions

---

The Model 812 has a variety of advanced functions that allow for gathering and storing great amounts of data with any given measurement. In this section you will learn how to access the parameters, choose the proper settings, and view some of the data collected.

### Time History

---

*Time History* records includes the RMS integrated level and, if selected, Peak, Unweighted Peak, or  $L_{\max}$ . Parameters 80-87 allow you to select the period for the history and what data are to be saved.

**Step 1** Turn the Model 812 on and access Time History parameters. Press **RCL** **SETUP** **LOG** **HIST**. The following screen, item 80, *Time history Enable* appears:

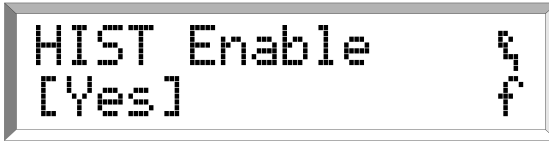

*Yes: With this item set to "Yes", the time history function is enabled. Despite Model 812's large memory, ensure anticipated requirements do not exceed available memory.*

**Step 2** To enter [Yes] press **Modify** **▶** to [Yes] and **Enter**.

**Step 3** Press the **▼** to item 81, *History Resolution:* (1.0 dB, 0.1 dB).

*Normally all data is taken with 0.1 dB resolution (2 bytes/level). To save memory, this option allows storage of history in 1.0 dB resolution.*

**Step 4** To change this setting press **Modify** **▶** **Enter**.

**Step 5** To access item 82, *Hist Save Peak* press **▼**:  
[No, Peak, UWPK, Lmax]

*This option allows saving the weighted peak (Peak), unweighted Peak (UWPK) or Max RMS level ( $L_{max}$ ) with each RMS history sample.*

**Step 6** You may press **Modify** and make your selection with **▶** and then press **Enter**.

**Step 7** Press the **▼** to item 83, *Hist Period:* (0-255 units)

*See the following step.*

**Step 8** Press the **▼** to item 85, *Hist Base*. The setting range is:  
(0-255 dB).

*This is for editing purposes only. All history is stored regardless of this base level. However, only data above the base level are displayed.*

**Step 9** To enter a value, press **Modify**, the value, **Enter**.

**Step 10** Press the **▼** to item 86, *Hist Base Mode:*  
[Off, RMS, Peak].

*This parameter controls the stored data which the preceding base level operates. For example, if this was set to Peak and the base level set to*

100 dB, only peaks 100 dB and above would be displayed.

**Step 11** To change the field press **(Modify)**, **(▶)**, and **(Enter)**.

**Step 12** Press the **(▼)** to item 87, *Histogram Resolution* for these options:

[1/8, 1/2, 1.0, 2.0, 5.0, 10]

*The Model 812 provides an amplitude distribution that can be read on the display. If the resolution is not satisfactory, a different one may be selected and the amplitude distribution re-displayed or printed. This is possible because all data is stored to the nearest 1/8 dB.*

**Step 13** Select the value you want. Press **(Modify)**, **(▶)** to the proper setting, and then press **(Enter)**.

## Time History Data

---

In Chapter 5 you learned how to take a measurement. To examine the History of that measurement take the following steps:

*The Time History is used to view the data that was acquired with the settings discussed in the previous section. In this example we are viewing the Leq and Peak data that was gathered during the history period.*

**Step 1** To access Time History, press **(LOG HIST)**, and a screen similar to the following will appear:



```
HIST  Leq  Key 4
      1 Pk  Key
```

*This display contains History information about the measurement. It was started by a key stroke.*

**Step 2** Press the  key to see what could be the beginning of dozens of readings depending upon your measurement:

Press the  key to view other readings.





HIST Leq 64.0%  
2 Pk 86.0

## Log and Data

---

The Log key function in SETUP is a Run/Stop log. It indicates how many times the measurement was started and stopped, and at what time.

Once the measurement is in progress, information can be examined as follows:

**Step 1** Press  and  and access Log screens:





LOG-a 1 %  
Key Run 1

*This screen gives you information about the most current readings. This measurement was started by a key stroke. If it had been started by preset alarm, "Key" would have been replaced with "Alm".*

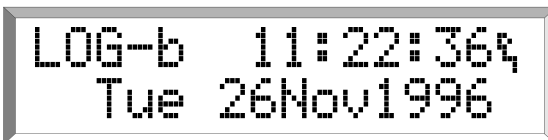
**Step 2** Press the  key for the next screen:





LOG-b 11:22:36%  
Tue 26Nov1996

**Step 3** Go back to LOG-a by pressing the  key. Toggle through the record logs by pressing :



LOG-a 2 %  
Key Stop 1







*The Log information indicates that the measurement was stopped by keystroke. If a low battery had been the reason for the measurement stopping, "BATT" would have appeared. To retain data already gathered, the Model 812 will terminate the measurement when battery power becomes low.*

**Step 4** The  and  keys may be used to look at additional records. Press the  to look at associated dates and times.

## Interval History

---

The *Interval History* Parameters allow you to select and define the interval size and determine what data are to be saved. Each interval gives you  $L_{eq}$ , SEL, Min, Max, Peak, UWPk, Exceedance count, and, if you turn this feature on,  $L_n$ 's. Listed below is each parameter and a brief explanation of its function.

**Step 1** To access the *Interval History* parameters press   . You may also use numeric values, i.e.   **Modify**   **Enter**. The choices are:

[Yes, No]

**Step 2** Press the  to access the next parameter, 73, *Intv Exchange Rate* for these choices:

[3dB, 4dB, 5dB, 6dB]

**Step 3** Press the  to item 74, *Intv Threshold*. You may find 80 dB preset but you may enter another value:

(0-255)

**Step 4** Press the  to item 75, *Intv Period*. Press **Modify** and the numeric values for the interval period desired, and then press **Enter**:

(hh:mm)

**Step 5** Press the  to *Intv Time Sync*, item 76, for these choices:

[Yes, No]

*With this item set to (Yes), the Interval Time History (ITH) is enabled. Note: Be sure that total memory requirements do not exceed available memory.*

*This parameter is the exchange rate used for each interval. Set this to 3 dB for community noise and 5 dB for OSHA studies.*

*This sets the TWA threshold for the interval time history. For hearing conservation purposes, 80 dB is recommended. For most community noise purposes, set this parameter to 0 or slightly above the noise floor.*

*This sets the period for the interval history. (A 1 second Interval may be selected by entering 00:00)*

*The Model 812 allows synchronizing the interval report with the Daily History Report. If (Yes) is entered, the Interval Report will be started (or restarted if already run-*

ning) at the start of each hour. For this to work properly the Interval Time should be one hour or some multiples of hours. The benefit of synchronizing the hourly levels and the interval reports is that all the statistics ( $L_{max}$ ,  $L_n$ , etc.) are available for the hourly noise levels that make up the daily report.

**Step 6** Press the  to item 77, *Intv Save  $L_n$ 's*. The Choices are:

[Yes, No]

Yes: This option allows the four  $L_n$ 's for the interval report to be stored.

**Step 7** Press the  to item 79, *Intv Auto Stop*. The choices are:

[Yes, No]

Yes: This option will cause the Model 812 to automatically stop at the end of each interval, allowing the precise timing of a series of manual measurements. To start a new measurement, the  key must be pushed.

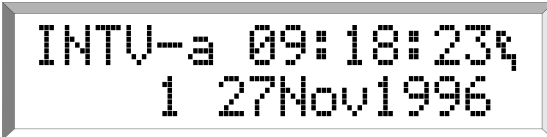

No: This mode must be off for all automated measurements. It is recommended that *Intv Time Sync* be set to "No" to get the full desired period.

**Step 8** To view Interval Histories after a measurement has been taken, press . A screen similar to the one below will appear:



INTV-a 09:18:23  
1 27Nov1996

Eight screens are available from the INTV mode. The screen at the left gives the Time and Date of a given Interval. Duration,  $L_{eq}$ ,  $L_{min}$  and  $L_{max}$ , Peak and UWPK, and the level setting measurements.

**Step 9** Examine the data available in each INTV. Press  and scroll to each. The  will also work and the scroll is a loop.

INTV-a gives time, interval number and date

INTV-b gives duration and interval number





INTV-c gives SEL and  $L_{eq}$ .

INTV-d gives min and max level and the number of times level went over RMS exceedance 1.

INTV-e gives peak and unweighted peak levels.

INTV-f-h gives statistical information.

**Step 10** Press the  or  keys to view the next or previous interval, respectively.

## Setting PassBy Functions

---

The *PassBy Function* is a special event detector that measures the  $L_{max}$ ,  $L_{eq}$ , and SEL of the highest single event to raise and lower  $\pm 10$  dB in SPL over the measurement period. It captures events such as a vehicle or aircraft passby, or other event noises such as blasts or gas getting noise. In addition to the levels measured, the date and time of the  $L_{max}$  and the duration of the event are recorded. The maximum duration of passby event may be 1 or 2 minutes depending on the shape of the event.

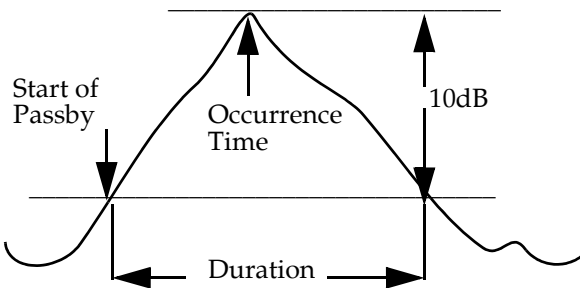

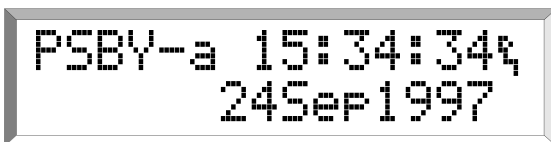



Figure 7-1 *Passby Diagram*

After taking a reading you may wish to examine the Max Passby event. You may also look at this while the instrument is running. To do this follow this step:

**Step 1** Press to view Passby.

**Step 2** Using the  or I keys, scroll through the information available in Passby:



*Four screens are available here by using the  key, giving time and date of the occurrence, duration, and  $L_{eq}$ .*

- a. PSBY-a: Time and date.
- b. PSBY-b: Duration of PassBy event.
- c. PSBY-c: SEL and  $L_{eq}$  of PassBy event.
- d. PSBY-d: Max RMS level and  $L_{eq}$  of PassBy record.

## Overload

---

It should be noted that during any measurement an *OVERLOAD* may occur. Such an occurrence happens when input exceeds all reasonable parameters set by the Model 812 (such as dropping or jarring the instrument). Should an *OVERLOAD* occur during a measurement, the data accumulated during the occurrence will not be accurate.

The Model 812 registers an *OVERLOAD* in the upper right corner of the display where the running figure appears. The figure takes one step each second. At intervals, 8 seconds apart, the letters O, V, L, D, will appear in succession. The measurement should be retaken. The Interval Report on the printout will indicate which interval had the *OVERLOAD*.



# Parameters

As we have seen in previous chapters, the Model 812 owes its versatility in great part to a flexible setup. More than 160 parameters and options can be selected to tailor the Model 812 to any measurement. Four preprogrammed setups for standard applications are in memory. One may use these as blueprints for modifications. It is also possible to store up to 3 other setups in memory for later recall. Along with downloadable setups from software, this truly makes the Model 812 a myriad of instruments in one.

In this chapter we will review the following:

- Parameter access keys, R m e c.
- Learn to store and retrieve complete setups from the various memory registers.
- List all parameters with a short explanation.

## Parameter Key Access Review

---

### Entering and Exiting the Setup Menu

---

Some setup items may be changed while the Model 812 is running, but parameters influencing data integrity require a memory Reset ALL.

**Step 1** Enter the setup by pressing . The following

will appear:

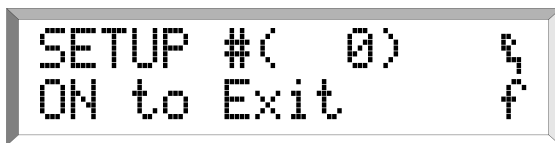

**Step 2** To exit back to the main screen, press **Cancel** .

**Step 3** Return to the setup menu. Press **RCL SETUP** .

## Locating Parameters

---

When in the setup menu, the arrow keys allow movement from one parameter to another. One may also use a function key or directly index to the appropriate parameters.

**Step 1** From the Setup menu press **↓** one parameter. Press **↓** to go to the next parameter.

All items in the list of parameters can be accessed by using the **↑** and **↓** .

**Step 2** When the arrow keys are used in conjunction with the Shift key, **SHIFT** , the Model 812 will take you to the top or bottom of the parameters list.

**Step 3** Press **SHIFT** **↓** to move to the bottom of the parameter list.

**Step 4** Press the **CAL SLM** key.

The Model 812 moves you to the RMS detector parameters

**Step 5** Press the **SHIFT** **Modify** keys and then **6** **1** . Press **Enter** .

*You are now at the beginning of the Exceedance parameters, item 61.*

NOTE: Numbers are entered at the current cursor position. Enter leading zeros if necessary.

## Changing Parameters — Enter, Modify

---

Parameters may consist of numerical values, character fields or selected choices. Numerical or character fields are shown between parentheses:



*This one has rounded brackets that mean this is an “entry parameter”. Type the number or character desired (see Chapter 4). If there is an angle bracket “>” then the entry field is too big to fit the screen and will scroll with the  key.*

Another parameter type is the template entry parameter. These prompt for specific data entry. For example:

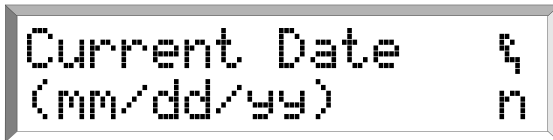

For both types, follow these simple steps:

**Step 1** Press .

**Step 2** Enter a value from the numerical keypad. Use the  key for alphabetical input.

*For complete coverage of numerical and alpha entry see chapter 4.*

**Step 3** Confirm any change with **Enter**.

**Step 4** Cancel any change by pressing **Cancel** before **Enter**.

Parameters whose value is selected from a few possible choices are displayed with the current setting inside square brackets:



```
Day Of Week    ↵  
[Wed]         f
```

To make a selection:

**Step 1** Press **Modify** and then the **Left Arrow** and **Right Arrow** keys.

**Step 2** Confirm change with **Enter**.

**Step 3** Cancel change by pressing **Cancel** before **Enter**.

## Error Messages

---

Entry errors will be noted by a warning message. For example:

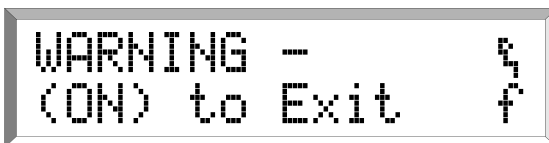

```
WARNING -      ↵  
(ON) to Exit  f
```

Verify the correct entry format.

## Learning to Store and Retrieve Setup Memory

---

The current setup parameters can be stored internally in two ways for later recall:



- In two RAM (random access memory) registers
- In one EEPROM register (electronically erasable programmable read-only memory)

Setups stored in RAM occupy the same memory as the data (64 KB). They may be lost if battery power is removed for more than a few minutes. One set of parameters at a time can be stored in the EEPROM. Parameters in the EEPROM register are secure even if the batteries are disconnected, since the EEPROM does not require bias voltage to maintain its state. A minimum of 5,000 STORE operations are possible with the EEPROM.

## Storing a Setup

---



The Model 812 must be stopped and memory reset to store to the EEPROM.

**Step 1** Press **SHIFT** **STR PRINT**:



*Remember, to reset memory press **SHIFT** **RESET R/S** **Enter**.*

*The EEPROM (.) register is the default. In this instance, the title of the measurement is "TECH WRITER".*

**Step 2** The   keys will scroll through the two RAM registers (0-9). For example, press  twice:



The RAM register "1" is empty.



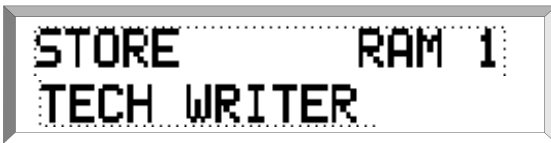

**Step 3** To store the current setup to the displayed RAM 1, register, press :



## Recalling a Setup

---

Memory must be reset before a recall of setup parameters can be accomplished.

**Step 1** In the stop mode, press    to reset memory. Then press  .



**Step 2** The EEPROM (.) is again the default. Use r and d to scroll through the two RAM registers or the programmed ROM setups.

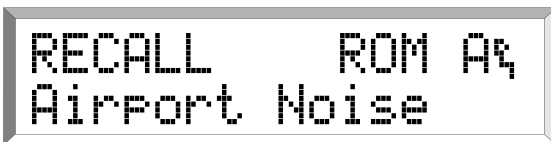

*RAM registers 0 to 9 and EEPROM register will recall previously stored calibration data. STORE saves the CAL data so that the calibration for several different microphones may be stored and recalled as desired. For example, Register 1 could store the calibration for a Model 2560 microphone, 2 for a Model 2540, 3*

for dB $\mu$ V. ROM registers A, B, and = do not affect calibration data.

## Model 812 Setup Parameters

---

Setup parameters of the Model 812 are listed below. Modifying some setup parameters, such as going from a FAST to a SLOW meter response, may not be allowed unless the data is reset. This prevents corruption of the overall noise data.

Parameters are listed below in logical groups, with their number and direct index key (if available). Valid entry formats are listed, (0), for numerical, [0], for selection. Some reserved parameters, or selections are not available. Many of these are active in the Model 870, the Model 812's big brother.

### System (1-20) R U S

---

The following parameters define measurement names, set clock and determine interface parameters.

No.	Prompt	Entry	Comment
1	Reset ALL Data?	[No Yes]	This parameter allows a <b>SHIFT</b>  without leaving SETUP. Note: If this parameter is set to Yes, a <b>RESET</b> will occur, and the parameter will automatically revert to No.
2-4	Name	(up to 30 characters)	Place any message you desire in these 3 lines. (The 3 lines of name are sav-able only in EEPROM.)
5	Title	(up to 30 characters)	Used to describe a measurement or setup
6	Current Time	(hh:mm:ss)	also accessed / U t

7	Current Date	(mm/dd/yy)	The 812 is year 2000 compliant. Leap years are considered. For years less than the year manufactured, the 21st century is assumed (2000-2092), otherwise the 20th century is used (1993-1999)
8	Day of Week	[Sun-Sat]	
9	Baud Rate	[300-19200]	Baud rate of the serial interface. Serial printer or computer rate should be the same.
10	RS-232 Address	(0-127)	Enables addressed communication mode for a network of Larson Davis SLMs. Each must have a unique address. Normally only one Model 812 is used, thus the address should be set to 0 to disable.
12	COM Ports Handshaking Register	[None, Hdwr, XOFF, Both]	Serial handshaking protocol. Model 812 -SW1 uses [None]. <i>Note: To conserve power, the Model 812 turns off the serial port after 255 sec. of non-use. To keep unit on and connected, an external power supply must be used.</i>
14	Output 1 Logic	Off RMS (R) PEAK (P) R + P INTV (I) R + I P + I R + P + I A:D R + A P + A R + P + A I + A R + I + A P + I + A R + P + I + A R/S	True takes it to 5 volts. When set to Off, DTR is DTR  Indication that Interval started and will stay on time set in parameter 15.  Logic control including “A” are not applicable to the Model 812.  Run/Stop

15	Output 1 Timer	(enter time)	There are 2 modes to the Logic Output Time now: If the time is set to 5 sec or less it is assumed to be a minimum time and the output will be asserted for a minimum of the time selected. If the time is programmed to be greater than 5 sec then the time is considered to be the maximum duration that the pulse should last and the output will be asserted for a minimum of 5 sec and a maximum of the time programmed.
20	Power Save	[Auto Off, Manual Off, Audio Off]	Auto Off: If in the Stop mode and if no keys are pressed or commands given for 12 min, the Model 812 will turn off automatically. Manual Off: The Model 812 will not turn off until the OFF key is pressed, a computer OFF command is given, or the batteries become low. Audio Off: Not available on the Model 812.

## Timer (21-27) U T

---

These parameters are used when Start and Stop of measurements are to be controlled by the clock.

No.	Prompt	Entry	Comment
21	Timer Mode	[Off, Block, 1/day, 2/day]	Block: Run Time 1 on Run Date to Stop Time 1 on Stop Date 1/day: Run Time 1 to Stop Time 1 each day from Run Date to Stop Date 2/day: Run Time 1 to Stop Time 1 and Run Time 2 to Stop Time 2 each day from Run date to Stop Date
22	Timer Run Date	(dd/mm/yy)	See Timer Mode comment

23	Timer Stop Date	(dd/mm/yy)	See Timer Mode comment
24	Timer Run Time 1	(hh:mm:ss)	See Timer Mode comment
25	Timer Stop Time 1	(hh:mm:ss)	See Timer Mode comment
26	Timer Run Time 2	(hh:mm:ss)	See Timer Mode comment
27	Timer Stop Time 2	(hh:mm:ss)	See Timer Mode comment

## **Lock (28-29) U P**

---

These parameters limit access of certain functions to those with the correct password.

**Step 1** After setting password and lock options, exit the setup and press U P to lock.

*For complete instruction on setting the Lock parameters, see chapter 6.*

**Step 2** To unlock, press UP, then m, and enter the password.

No.	Prompt	Entry	Comment
28	Lock Password	(8 characters)	Enter your password
29	Lock R/S Key	[No, Yes]	Lock mode change

## Calibration (35-36) U C

---

No.	Prompt	Entry	Comment
35	CAL Level	(114.00) (0-255 dB)	Enter the sound pressure level of your calibrator
36	Calibrator S/N	(to 8 char.)	Calibrator serial no. will be printed

## Sound Level Meter (39-50) C

---

These parameters define the sound level meter characteristics. Most changes will require a US if memory holds previous data.

No.	Prompt	Entry	Comment
39	Detector	[Slow, Fast, Impl]	Slow: exponential avg: 1 second constant. Fast: exponential avg: 1/8 second constant. Impl: impulse response.
40	Frequency Weighting	[A,A16,C,C16]	A and C weightings meet Type 1 specifications. Note: A16 and C16 not applicable to the Model 812.
41	AC Out Weighting	[Flat, Wght, F+20, W+20]	F+20: Flat Level with 20 dB gain. W+20: Weighted with 20 dB gain.
42	Unweighted Peak	[Flat, C]	
43	Mic. Polarization Voltage	[0, 28, 200]	This selects the polarization voltage for the microphone. Chose 28 or 200 V for condenser type microphones and 0 V for pre-polarized microphones (electret).
44	Reference Level	(0 to 255 dB)	measured level - reference level = relative level used in some functions
45	Currant Exchange Rate 1	[3dB,4dB,5dB,6dB]	Exchange rate for currant TWA or Dose readings. For OSHA use 5dB.

46	Current Threshold 1	(0 to 255 dB)	Levels above threshold are integrated into current TWA or Dose readings. For OSHA use 80 dB.
47	Current Criterion 1	(0 to 255 dB)	100% dose if this level is maintained for full dose period. For OSHA use 90 dB.
48	Overall Exchange Rate 2	[3dB,4dB,5dB,6dB]	Exchange rate for overall TWA or Dose readings.
49	Overall Threshold 2	(0 to 255 dB)	Levels above threshold are integrated into overall TWA or Dose readings.
50	Overall Criterion 2	(0 to 255 dB)	100% dose if this level is maintained for full dose period.

## Dose (51) o

---

The noise exposure Dose may be calculated with three different set of parameters: CURRENT, OVERALL, and LDL. See section on occupational noise for additional information. The dose displayed with the o key is Dose 2.

No.	Prompt	Entry	Comment
51	Full Dose Hours	(0 - 99)	This is normally set to 8 for an 8 hour workday. It is used with the criterion level to determine a 100% projected dose.



## **L<sub>N</sub> Statistical Levels (55-58) B**

---

L<sub>nn</sub> is the rms noise level which was exceeded **nn**% of the time. The L<sub>n</sub>'s are computed from the overall level distribution histogram or each interval's level histogram (see item 77). The measured and displayed L<sub>nn</sub> may be changed during the measurement. The six **nn** are automatically listed in increasing order.

No.	Prompt	Entry	Comment
55	Lnn 1 Percent	(0 to 99)	
56	Lnn 2 Percent	(0 to 99)	
57	Lnn 3 Percent	(0 to 99)	
58	Lnn 4 Percent	(0 to 99)	

## **Exceedance Level Count (61-65) V**

---

These parameters define noise threshold levels to be used when counting the number of exceedances during a measurement (viewed in MAX-b and c displays for rms, PEAK-b, and UWPK-b for peak exceedance ).

No.	Prompt	Entry	Comment
61	RMS Excd Lvl 1	(0 - 255 dB)	First rms detector exceedance level.
62	RMS Excd Lvl 2	(0 - 255 dB)	Set above Level 1.
63	Peak Excd Level	(0 - 255 dB)	Weighted peak exceedance level.
64	Uwpgk Excd Level	(0 - 255 dB)	Unweighted peak exceedance level.

65	Excd Hysteresis	(0 - 9)	This sets the amount, once an exceedance occurs, that the level must drop below the exceedance level before the Exceedance event ends and a new exceedance can occur. Normally set this level to 2 or 3 dB. This prevents multiple exceedances for a single event if the level flickers around the threshold.
----	-----------------	---------	---

### Interval History (72-79) M

No.	Prompt	Entry	Comment
72	Intv Enable	[No, Yes]	Interval report will be stored in memory if Yes is entered.
73	Intv Exchange	[3dB, 4dB, 5dB, 6dB]	Used to calculate interval integrated level. Normally this is set to 3 dB (Leq). 4 dB gives L_DOD, 5 dB: LOSHA, 6 dB: L_Avg.
74	Intv Threshold	(0 to 255 dB)	Levels above threshold are integrated during each interval, normally 0 dB for Leq. For noise hygiene interval TWA, set to dose threshold.
75	Intv Period	(hh:mm)	This sets the period for the interval history from 1 minute up to 99:59. A 1 second interval may also be selected by entering 00:00.
76	Intv Time Sync	[No, Yes]	Synchronizes start of interval with clock and daily history report. If Yes is entered, the interval report will be started (or restarted if already running) at the start of each hour or minute depending on Intv duration.
77	Intv Save Ln's	[No, Yes]	Selects whether interval Ln's are stored. The Ln's stored are those in effect (items 55-60) at end of interval.

79	Intv Auto Stop	[No, Yes]	If yes, automatically stops instrument at the end of each interval for precise timing of series of manual measurements. Use R/S key to restart.
----	----------------	-----------	---

## Time History (80-87) H

This third type of history is the most conventional. The rms integrated level and, if selected, a maximum reading are stored in memory at the end of each time history period.

No.	Prompt	Entry	Comment
80	HIST Enable	[No, Yes]	Time history report will be stored if Yes is entered. Despite the Model 812's large memory, ensure anticipated requirements do not exceed available memory.
81	Hist Resolution	[0.1dB, 1.0dB]	Normally, all data is taken with 0.1 dB resolution (2bytes/level). Allows storage of history with 1 dB resolution to conserve memory(1byte/level).
82	Hist Save Peak	[No, Peak, UWPk, Lmax]	This option allows saving the history period's highest weighted (Peak), unweighted Peak (UWPk) or rms level (Lmax) with each RMS history sample.
83	Hist Period	(1-255 units)	Multiplier of units of time in parameter #84 sets rate at which history samples are stored. Ex: 1 x 60.0s for minute by minute history, 16 x 1/32s for 0.5 second history.
85	Hist Base	(0-255 dB)	This is for editing purposes only. All history is stored regardless of this base level. However, only noise data above the base level are displayed on the screen.

86	Hist Base Mode	[Off, RMS, Peak]	Type of noise data used by the base mode
87	Hist Resolution	[1/8, 1/2, 1.0, 2.0, 5.0, 10]	Selects the interval in dB of the overall time level amplitude distribution.

## Print Options (89-112) s

---

These parameters allow for tailored reports of the Model 812 data during or after the measurement. They can be accessed from outside the SETUP by pressing s, then 7 for printer type and options. Refer to section on printouts for samples of information found on each printout.

No.	Prompt	Entry	Comment
89	Prn Data Report	[No, Yes]	Prints quick data report.
90	R/S and Cal Log	[No, Yes]	Prints Run/Stop and calibration log report.
91	Setup Report	[No, Yes]	Prints list of current setup parameters.
92	RMS Histogram	[No, Yes]	Prints histogram of overall rms levels.
93	Lowest Level	(0 - 255)	RMS Histogram lowest printed level
94	Highest Level	(0 - 255)	RMS Histogram highest printed level
95	Histogram Resl.	[1/8, 1/2, 1.0,2.0,5.0,10]	Spacing in dB between histogram entries
96	Peak Histogram	[No, Yes]	Prints histogram of overall peak levels.
97	Lowest Level	(0 - 255)	Peak Histogram lowest printed level
98	Highest Level	(0 - 255)	Peak Histogram highest printed level
99	Histogram Resl.	[1.0,2.0,5.0,10]	Spacing in dB between histogram entries
100	UwPk Histogram	[No, Yes]	Prints histogram of overall unweighted peak levels.

101	Lowest Level	(0 - 255)	UWPk Histogram lowest printed level
102	Highest Level	(0 - 255)	UWPk Histogram highest printed level
103	Histogram Resl.	[1.0,2.0,5.0,10]	Spacing in dB between histogram entries
107	INTV Report	[No, Short, Long]	Prints interval report
108	Lowest Rec. #	(0 - 65535)	Starting interval record number of printout
109	Highest Rec. #	(0 - 65535)	Ending interval record number of printout
110	HIST Report	[No, Yes]	Prints time history report
111	Lowest Rec. #	(0 ->999999)	Starting history record number of printout
112	Highest Rec. #	(0 ->999999)	Ending history record number of printout



## Memory Usage

Each of the Model 812's History Functions use space out of a common memory. The amount each record takes is based on the options selected. In this chapter we will provide information that will assist you to:

- Determine the amount of storable data considering the given options.
- Estimate memory usage by giving an example of a test reading and an associated chart to determine the memory needed to complete the reading.

### Determine Storable Data

---

The following tables indicate the amount of memory used for each type of record:

Interval Records	Intv History Enable = [Yes] Prm 72
Options -- add bytes shown if enabled	Bytes
Basic Interval Record	34
Intv Save L <sub>n</sub> 's = [Yes] Prm 77	18

Time History Records		Time History Enable = [Yes] Prm 80
Options	Options	
Hist Resolution Prm 81	Hist Save Peak Prm 82	Bytes

[1.0dB]	[No]	1
[0.1dB]	[No]	2
[1.0dB]	[Peak, UwPk, Max, Wind]	2
[0.1dB]	[Peak, UwPk, Max, Wind]	4

<b>Other Histories and Memory Usage</b>	<b>Bytes</b>
Run Log History	20 bytes per record
Calibration Log History	17 bytes per record
Ram Setup Register (REgisters 0-9, Bytes used per register stored)	506 bytes per register



# Estimating Memory Usage

---

The easiest way to estimate the memory usage is to work on a time basis such as one day. Consider the following:

- Calculate the number of Interval, Time History, Run Log and Calibration Check records that will be performed in a day.
- Based on the options chosen calculate the number of bytes required for each record type.
- Multiply by the number of records expected per day,
- Sum these values and this is the number of bytes required per day.
- Divide this value into the amount of available memory in the Model 812 (see U M) and this is the number of days the Model 812 can gather data.

As an example:

Line	Interval Memory Estimation	Bytes	✓Used	Bytes needed
6	Basic Interval Record	34	✓	34
7	Intv Save L <sub>n</sub> 's=[Yes] P <sub>rm</sub> 77	18	✓	18
8	Intv Save L <sub>n</sub> Table	384		0
9	TOTAL Bytes / Intv	sum lines 6-8		52
10	Anticipated Intv / Day	Enter Number		24
11	TOTAL Bytes / Day	Multiply lines 9 & 10		1248

Line	Time History Memory Calculation	Bytes	Bytes
	Hist Resolution	Hist Save Peak	
16	[1.0dB]	[No]	1

Line	Time History Memory Calculation	Bytes	Bytes
17	[0.1dB]	[No]	2
18	[1.0dB]	[Peak   UwPk   Max   Wind]	2
19	[0.1dB]	[Peak   UwPk   Max   Wind]	4
20	TOTAL bytes / Hist Record	Select the appropriate # of bytes from lines 16 - 19	2
21	Hist Records / Day 24 hours divided by Hist Period in hours	Enter Number Calculate i.e. 24/(60 sec/3600 sec per hour)= 1440	1440
22	TOTAL Hist Bytes / Day	Multiply lines 20 and 21 - copy to 26	2880

Line	Memory Use per Day Calculation	Bytes	Bytes
24	Interval History bytes / day	from line 11	1248
26	Time History bytes / day	from line 22	2880
27	Run Log bytes / day n= number of Run Log records / day	$2 / (n \times 20) \times 20 =$ n x 20 bytes/record	40
28	Calibration Log bytes / day	$1 / (n \times 17) \times 17$ n x 17 bytes/record	17
29	Setup RAM Registers bytes used n=number of registers stored / day	$0 / (n \times 506) =$ n x 506 bytes/record	0
30	TOTAL bytes used / day	Sum lines 23-29	4185
31	Model 812's Memory Size (64000)	See SYSTEM-b	64000
32	<b>TOTAL Run Time in days</b> until out of memory	Divide line 32 by 31	15.29

## Printing a Report

The Model 812 allows for tailored reports of data during and after measurements. In this chapter we will access the printing option parameters for Normal Printouts and print a report.

### Normal Printout Parameters

---

Before proceeding with printing, baud rate needs to be determined and entered. Set parameter 9 to proper baud rate determined by type of printer used. If, after starting printing, bad information is printed, baud rate or printer type is probably set incorrectly. To cancel printing, hit **SHIFT** and **RESET R/S**.

Normal printouts can be accessed from outside the SETUP mode by following these steps:

- Step 1** Turn the Model 812 on and press **s**. The following display will appear briefly and then scroll automatically through several options:

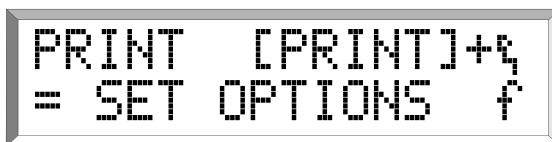

```

PRINT [PRINT]+&
= SET OPTIONS f
  
```

- Step 2** To tailor your report and select the printer type and options, press **7** and the following screen

will appear:



There are several options here which include:

[HP]et, HPLzr, ASCII, Epson, IBM]

**Step 3** You can change the printer selection by pressing the **(Modify)** key and then **(▶)** to the printer you will use, and press **(Enter)**.

**Step 4** Press the **(▼)** key to the next display, item 89 (duplicated here as item 177), the beginning of the parameters that manage printouts:



**Step 5** Scroll through these parameters with the **(▼)** key and make your selections. Press **(Modify)** to access the appropriate choice and press **(Enter)**.

*Items 89-112 allow you to select the reports which are to be printed and how the output data are to be configured.*

*Items 89-112 are copied sequentially into items 177-200 for printing tailored reports, and may be edited directly for one printing, and then they will revert to settings of parameters 89-112.*

*For a complete list of Print Options, see Chapter 8.*

# Printing Reports

---

Printing reports is easy as connecting your Model 812 to a printer and pressing a key. Using the CBL033 serial printer cable, connect your *serial* printer to the Model 812 at its bottom port. Let's look at the print options again:

**Step 1** Turn the Model 812 on and press . The display will begin to scroll through the various print options available. Here are some of the screens:



```
PRINT [RESET]+&
= ALL DISABLED f
```



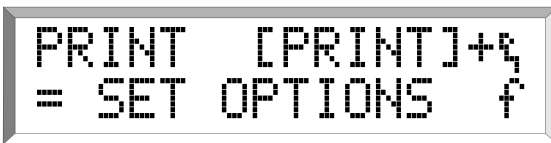

```
PRINT [SETUP] &
= SETUP LIST f
```

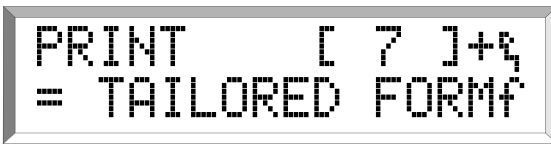

```
PRINT [PRINT]+&
= SET OPTIONS f
```



```
PRINT [ 7 ]+&
= TAILORED FORMf
```

*You will notice that the scroll is quite rapid. To slow it down so you can study the options, use the  or  keys and the display will remain for five seconds before returning to automatic scroll.*

*This option allows you to access the printer setup status.*

*This option will return you to the Printout Parameters and will start with the printer type selection. The  key will access item 89 of the Printout Parameters.*

*This option allows you to tailor your own report changing the settings of parameter items 89-112 but inputting the entries in items 177-200. After the printout is complete, the values will revert back to factory settings.*



# A

## *Specifications*

This Appendix contains the specifications for the Model 812 in the following order:

- Type
- Reference Direction
- Measurement Ranges
- Reference Level
- Frequency Weighting
- Detector Time Weightings
- Effects of Temperature
- Effects of Humidity
- Limits of Temperature and Humidity
- Microphone Extension Cables
- Positioning of Instrument and Observer for Best Measurements
- AC and DC Outputs
- Reference Frequency
- Stabilization Time
- Microphone Electrical Impedance
- Functions Measured
- Data Storage

- Data Communications
- Digital Display
- Digital Display Resolution
- Display Bargraph
- Real-time Clock/Calendar
- Run-time Clock
- Typical Noise Floors
- Standards Met
- Power Supply
- Dimensions/Weight (with Microphone, Preamplifier, and Battery)

## Type

---

The Larson Davis Model 812 with attached PRM 828 preamp and Model 2541 microphone is a combination Type 1 precision integrating sound level meter and statistical data logger. The Model 812 can also be used with any of the Larson Davis 1/2" condenser microphones. They may also be used with any Larson Davis 1/4" or 1" microphones provided they are used with an ADP011 (1/4"to 1/2"preamp adapter) or an ADP008 (1" to1/2" preamp adapter) attached to the PRM 828. The Model 812 polarization voltage can be set to either 200V or 28V.

## Reference Direction

---

The reference direction is perpendicular to the plane of the microphone diaphragm when using a free field microphone (e.g. Larson Davis 2540 or 2541) in a free field. The microphone should be pointed directly at the source.



When using a random incident microphone in a free field, the microphone should be pointed 80 degrees off axis of the source of the sound.

When in a random sound field, a random incident microphone (e.g. Larson Davis 2559 or 2560) may be pointed in any direction.

## Measurement Ranges

---

### RMS Detector

---

Dynamic Range > 110.0 dB

Primary Indicator Range > 105.0 dB

The instrument will have a different Noise Floor, Lower Limit, and Overload Level, depending on the sensitivity of the microphone used. Some typical values, for 2 different Larson Davis microphones, are listed in the table below.

Microphone	A Weight Noise Floor - dB SPL	C Weight Noise Floor - dB SPL	Lower Limit dB SPL	Overload Level dB SPL	Max Peak Level dB SPL	Max Level for Pulses of Crest Factor = 10 dB SPL
2541	17.5	16.5	23.5	130.0	133.0	112.0
2559	29.0	28.0	35.0	141.5	144.5	123.5

The data in the above table was obtained by electrically testing a number of instruments. For all electrical tests, the microphone was replaced with an equivalent electrical impedance (Larson Davis ADP005 microphone adapter).

## Other Detectors

---

- Weighted Peak Detector = 85.0 dB
- Unweighted Peak Detector = 38.0 dB
- AC Output = 88.0 dB
- DC Output = 105.0 dB

## Reference Level

---

The reference level is 114.0 dB SPL.

## Frequency Weightings

---

The available frequency weightings for the Models 812/820 are described in the table below.

Detector	A Weight	C Weight	Flat Weighting
RMS	√	√	
Weighted Peak	√	√	
Unweighted Peak		√	√
AC Output	√	√	√
DC Output	√	√	

NOTES:

1. The RMS frequency weighting is selected via parameter #40, "Frequency Weighting". The Weighted Peak Detector, and DC Output frequency weighting always

matches the RMS Detector frequency weighting.

2. The Unweighted Peak Detector frequency weighting is selected via parameter #42 "UWPK Weighting"; therefore, it can be set independent of the RMS Detector frequency weighting. The Unweighted Peak Detector's typical FLAT frequency response is shown in the table below.

3. The AC Output frequency weighting is selected via parameter #41, "AC Out Weighting". It can be set to Flat weighting, or it can be set to match the RMS Detector frequency weighting. The AC output's FLAT frequency response is shown in the table below.

#### Unweighted Peak FLAT Frequency Response

Nominal Frequency Hz	Unweighted Peak FLAT Weighting - dB	Nominal Frequency Hz	Unweighted Peak FLAT Weighting - dB	Nominal Frequency Hz	Unweighted Peak FLAT Weighting - dB
10	-3.4	160	0.0	2500	0.0
12.5	-2.5	200	0.0	3150	-0.1
16	-1.7	250	0.0	4000	-0.2
20	-1.2	315	0.0	5000	-0.2
25	-0.8	400	0.0	6300	-0.3
31.5	-0.5	500	0.0	8000	-0.4
40	-0.3	630	0.0	10000	-0.5
50	-0.2	800	0.0	12500	-0.8
63	-0.1	1000	0.0	16000	-0.9
80	0.0	1250	0.0	20000	-1.2
100	0.0	1600	0.0		
125	0.0	2000	0.0		

#### AC Output FLAT Frequency Response

Nominal Frequency Hz	AC Output FLAT Weighting - dB	Nominal Frequency Hz	AC Output FLAT Weighting - dB	Nominal Frequency Hz	AC Output FLAT Weighting - dB
10	-7.6	160	-0.1	2500	0.0
12.5	-6.2	200	-0.1	3150	0.0
16	-4.7	250	-0.1	4000	0.0
20	-3.5	315	0.0	5000	0.0
25	-2.5	400	0.0	6300	0.0
31.5	-1.7	500	0.0	8000	-0.1
40	-1.2	630	0.0	10000	-0.1
50	-0.9	800	0.0	12500	-0.2

### AC Output FLAT Frequency Response

63	-0.6	1000	0.0	16000	-0.3
80	-0.3	1250	0.0	20000	-0.5
100	-0.3	1600	0.0		
125	-0.2	2000	0.0		

---

## Detector Time Weightings

---

The available RMS detector time weightings are FAST, SLOW, and IMPULSE. There are also two available PEAK detectors (Weighted Peak, Unweighted Peak).

- Weighted Peak Detector Rise Time: 60  $\mu$ s
- Unweighted Peak Detector Rise Time: 30  $\mu$ s

## Effects of Temperature

---

The SPL level varies  $\pm$  0.5 dB when the complete instrument is tested over the -10° C to 50° C temperature range. The reference reading, for this test, is taken at 20° C and 36% relative humidity (RH); the input signal is at 1000 Hz.

## Effects of Humidity

---

The SPL level varies  $\pm$  0.5 dB when the complete instrument is tested over the 30% to 90% RH range. This test is performed at 40° C, with an input signal of 1000 Hz.

## Limits of Temperature and Humidity

---

Permanent damage can occur when stored or operated above 60° C or below -20° C. Condensation of moisture will make readings inaccurate but will be correct when moisture has dissipated.

## Microphone Extension Cables

---

When measuring signals below 20 kHz, up to a 12 foot microphone extension cable may be used with the model 812.

## Optimal Positioning of Instrument and Observer

---

Measurements can be made with the model 812 held in one hand, with the arm extended away from the body; however, better measurements can be made with the Model 812 placed on a tripod.

## AC and DC Outputs

---

The output impedance is  $600 \frac{3}{4}$  for both the AC and DC outputs of the Model 812. For minimal error use instruments with  $\geq 100 \text{ k}\Omega$  input impedance when making AC or DC output readings.

### AC Output

---

- Output Impedance:  $600 \Omega$
- Gain: 0 dB or 20 dB (User Selectable)
- Measurement Range: 88.0 dB

## DC Output

---

- Output Impedance: 600  $\Omega$
- Scale: 20 mV/dB
- Measurement Range: 105.0 dB
- Voltage Range: 0 to 3 volts
- Temperature Coefficient: 936  $\mu\text{V}/^\circ\text{C}$

## Reference Frequency

---

The reference frequency is 1000 Hz.

## Stabilization Time

---

The model 812 will not proceed to a running condition until it is allowed to stabilize. At power-on, with the polarization voltage set to 200V or 28V, the stabilization time is approximately 45 seconds. With the polarization voltage set to 0V, the stabilization time is approximately 10 seconds. A shorter stabilization time is also invoked when certain settings (Weighting, Detector, etc.) are changed.

## Microphone Electrical Impedance

---

The Larson Davis ADP005 should be substituted for the 1/2" microphone when performing electrical tests on the Model 812. The Larson Davis ADP002 is used in place of a 1/4" microphone, and the Larson Davis ADP006 is used in place of the 1" microphones.

## Functions Measured

---

- $L_{eq}$ ,  $L_{max}$ ,  $L_{min}$ , TWA, SEL
- Dose, Projected Dose, Ln (1% - 99%)
- Sound Exposure in pascal squared hours (SE in Pa<sup>2</sup>H)
- Time History, Histograms, Measurement Time-Date-Duration
- Taktmaximal 3 and 5

## Data Storage

---

- 812: 64k byte Memory

Typically, 3 month memory retention with fresh battery.

Memory protected during battery change (2 minutes minimum).

## Data Communications

---

- Serial interface for computer, printer, and modem communications
- Data Rate: 19,200 bits per second

## Digital Display

---

- 2 line, 32 digit, 7 segment LCD
- Full ASCII character set
- Fully annotated date displays parameter with units



## Digital Display Resolution

---

- dB levels: 0.1 dB
- Dose: 0.01%
- Elapsed Time: 0.1 second

## Display Bargraph

---

- 120 dB range, 1 dB resolution for SPL

## Real-time Clock/Calendar

---

- 24 hour clock: hh:mm:ss
- 1 second resolution
- 100 year calendar: 01JAN1999
- Automatic run/stop timer with two alarms and four alarm times

## Run-time Clock

---

- 0.1 second resolution
- Format: hhhhh:mm:ss.s
- Maximum > 4 years

## Standards Met

---

- ANSI S1.4-1983 Type 1
- ANSI S1.25-1991 Type 1
- IEC 651 Type 1

- IEC 804 Type 1
- Directive 86/188/EEC
- Directive IEC/TC-29

## **Power Supply**

---

- Internal: 9 V battery, typically 20 hour operation (actual run-times vary depending on operating conditions)
- External: 7 to 16 VDC, 30 mA current drain
- Battery-life indication selected from keyboard or computer program

## **Dimensions/Weight (with Microphone, Preamplifier and Battery)**

---

- Width: 3in. (7.6 cm)
- Length: 13 in. (33 cm)
- Depth: 1.0 in. (2.5 cm)
- Weight: 13 oz. (370 gm)
- Weight (w/o preamp & microphone): 11 oz. (310 gm)
- Shipping weight: 3 lbs (1.4 kg)

**B***Serial Port Interface Remote Control*

The Model 812 is fully controllable remotely via Serial Port interface. Setup items and operational mode can be altered. Data can also be dumped to or queried by the controlling computer.

The Model 812 may be connected to the computer directly or through a modem. A network of many instruments can be formed, all controlled by one computer by using the address-ability mode.

This chapter will describe the Serial Port interfacing of the Model 812 and the various interface commands with their syntax. Modem control is also covered. These commands are a subset of the Larson Davis Model 870 commands.

In this chapter we will cover the following items:

- Model INT002 Interface Cable.....2
- Daisy Chain Addressing.....3
- Commands .....3
- Group Read Programming.....11
- Setting Parameters.....12
- Query Parameters.....15
- History Records .....23
- History Data Variables.....25
- Print Commands.....28
- Error Messages and Warnings.....29

## Model INT002 Interface Cable

---

The Serial Port communication is made through the 5-pin connector at the base of the Model 812. Interface, interface signals usually need to be converted for proper communication with desktop computers. The Model INT002 Cable/level converter is required for this purpose. Its electronic circuits provide the correct signal levels and polarities. When used with the AC/DC adapter, the INT002 also powers the units externally, minimizing battery depletion which can be substantial during Serial Port transfers.

**Step 1** With the instrument turned off, insert the cable connector in the 5-pin port.

**Step 2** Connect the cable to the of the computer, using the supplied 9-25 pin adapter if necessary.

*Baud rate, Serial Port address and handshaking protocol are selected using parameters 9, 10 and 12. Unless using addressing, set the address to (0).*

Signal 5-Pin configurations for the INT002 follow:

812 5-pin Connector End		Computer DB-9 Connector End
Ground	Pin1/Shield	Pin5/Shield
TXD	Pin 2/Red	Pin 3/Red
RXD	Pin3/Yellow	Pin 2/Yellow
Power	Pin4/Blue	
DTR	Pin 5/White	Pin 4/Blue
DSR		Pin 6/White
CTS		Pin 8/White

## Daisy Chain Addressing

---

A network of instruments may be interconnected to one computer using the appropriate cabling, such as the CBL040, and each may be controlled individually. Each is given a unique address (parameter or item 10). The addresses are sent as a single byte ranging in value from 129 to 255 representing address 1 to 127 respectively (address plus 128). Whenever an address byte is received only the corresponding instrument is enabled to receive commands.

*The following instruments are compatible on a common network: Models 712, 720, 812, 820, 870, and TAC100. Future instruments may also be compatible with this network.*

A broadcast command can be sent. By sending an address of zero, CHR\$(128), all units on the chain will become addressed and accept the commands that follow. Only the device with an address of 1 will respond to the commands if data transfer is required. This will allow all units to be started at the same moment, or to have the same parameter sent to all devices with one command, i.e. set all clocks to the same time.

These devices cannot be just paralleled together. That would short outputs together and damage the instruments. Use the designated cables.

## Commands

---

The commands are a series of ASCII characters with an alpha command and one or two numeric operands followed by a charge return, ASCII 13. The commands may be spelled out though only the first character is significant. i.e. READ 123 may be abbreviated to R123. Every command has a response to acknowledge that it was received correctly and to provide data requested. For high reliability systems there is an error-checking protocol that is added to ensure proper command data transferal. See Error Checking Protocol on page 34.

The following tables summarize all of the commands and are listed in this order: mode control commands first, parameter commands next, data extraction command and report/data download command last.

[.] Square brackets indicate optional characters or operands.

Syntax	Response
R[ead] variable_number 0, operand_2]	variable_value
S[et] parameter_number, parameter_value	acknowledge
S[et] parameter_number, fixed_parameter_index	acknowledge
S[et] parameter_number; fixed_parameter_prompt	acknowledge i.e. "Set 8; [Thu]" will set day of week to Thursday
Q[ue]ry parameter_number 0, option_flags]	parameter_value

Option flags may be added for combined effect.

32-Index Number	
8-Tab over response	
2-print in braces	
1-Print parameter name	
K[ey] key_simulation_string	acknowledge
M[ode] mode_number	acknowledge

## History Oriented Commands

I[nterval] variable_number [,relative_rec#]	variable_value
L[og] variable_number [,relative_rec0,	variable_value
C[alibration] variable_number	variable_value
H[istory] variable_number [,relative_rec#]	variable_value
T[ables] variable_number [, table]	variable_value
A[dvance] range [,history_number]	acknowledge
B[ackup] range [,history_number]	acknowledge
F[ind] record_number [,history_number]	acknowledge
P[rint] report_number	acknowledge

## Mode Commands

---

Format for the Mode Commands is:

Command	Description
M 1	Power On, clear error message list and reset display functions to “-a” windows
M 2	Power Off
M 3	Run
M 4	Stop
M 5	View
M 6	Mark
M 7	Reset Current Data (use S1,1 for Reset-All)

M 8	Reset Histories Only
M 9	High Resolution Levels (to I/O channel only). Increased resolution I/O is possible by using the M9,1 command. All sound levels are then sent with an additional fractional character (nnn.nn) giving 1/100th dB resolution. The Model 812 acquires noise data with 1/32 dB resolution. Greater resolution is achieved through averaging. <b>HOWEVER, THIS DOES NOT IMPROVE ACCURACY.</b> Refer to the specifications or device specific performance results for the accuracy of the system.
M 10	Lock 812 (leave 812's power on)
M 11	Lock 812 and Power Off.To unlock the unit and send the lock combination to the unlock parameter with the S230,ccccccc command where ccccccc is the correct combination entered before locking.
M 1000	Non-destructive memory test (walking bit)
M 1001	Destructive memory test (pattern test)

## “Read” Variables

---

Syntax	Variable	Description	Response
R 1	_DEVTYPE	Device manf. and model	String
R 2	_DT.TM	Current Date and Time	ddd ddmmmyyyy hh:mm:ss
R 3	_STAT	Status	RUN/PAUSE/STOP/RESET-C/RESET-O, LOCKED

A short form of the status command is R3,1 which has a 5 character response.

- The first is an “s” when stabilizing or a space when stable.
- The second is the current mode: “S” for Stopped, “R” for Running, “P” for Paused, “C” for Calibrating, “V” for View mode, “O” for stopped with overall data reset and “C” for stopped with Current data set reset.
- The third character is the Lock Status and is either an “L” or a “U”. The fourth character is the Halt Line Status and is a “1” if high and a “0” if low. The fifth or last character will be an “a” if an Alarm has been detected.

R 4	_C.SPL	Current SPL	nnn.nn dB
R 5	_O.RTIME	OverAll Runtime	hhhhh:mm:ss.s
R 6	_O.STIME	OverAll Start Date and Time	ddmmmyy hh:mm:ss



R 7	_C.RTIME	Current Runtime	hhhhh:mm:ss.s
R 8	_C.STIME	Current Start Date and Time	ddmmmyy hh:mm:ss
R 9	_O.TWA	Overall TWA (Time Wght Avg)	nnn.n dB
R 10	_O.XR	Overall Exchange Rate Text	cccc
R 11	_C.TWA	Current TWA (Time Wght Avg)	nnn.n dB
R 12	_C.XR	Current Exchange Rate Text	cccc
R 13	_O.SEL	Overall SEL	nnn.n dB
R 14	_C.SEL	Current SEL	nnn.n dB
R 15	_O.LMIN	OverAll Minimum Level	nnn.n dB
R 16	_O.TMIN	OverAll Lmin Date and Time	ddmmmyy hh:mm:ss
R 17	_C.LMIN	Current Minimum Level	nnn.n dB
R 18	_C.TMIN	Current Lmin Date and Time	ddmmmyy hh:mm:ss
R 19	_O.LMAX	OverAll Maximum Level	nnn.n dB
R 20	_O.TMAX	OverAll Lmax Date and Time	ddmmmyy hh:mm:ss
R 21	_C.LMAX	Current Maximum Level	nnn.n dB
R 22	_C.TMAX	Current Lmax Date and Time	ddmmmyy hh:mm:ss
R 23	_O.LPEAK	OverAll Peak Level	nnn.n dB
R 24	_O.TPEAK	OverAll Lpeak Date and Time	ddmmmyy hh:mm:ss
R 25	_C.LPEAK	Current Peak Level	nnn.n dB
R 26	_C.TPEAK	Current Lpeak Date and Time	ddmmmyy hh:mm:ss
R 27	_O.LUWPK	OverAll UWpk Level	nnn.n dB
R 28	_O.TUWPK	OverAll Luwpk Date and Time	ddmmmyy hh:mm:ss
R 29	_C.LUWPK	Current UWpk Level	nnn.n dB
R 30	_C.TUWPK	Current Luwpk Date and Time	ddmmmyy hh:mm:ss
R 31	_RMSCNT	OverAll RMS Exceedances #1	nnnnn
R 32	_RMSCNT2	OverAll RMS Exceedances #2	nnnnn
R 33	_PEAKCNT	OverAll Peak Exceedances	nnnnn
R 34	_UWPKCNT	OverAll UWpk Exceedances	nnnnn
R 35	_OVLDCNT	Overloads	nnnnn
R 36	_PSECNT	Number of PAUSES	nnnnn
R 37	_PTIME	PAUSE Time (OFF not inc.)	hhhhh:mm:ss

R 38	_LN1	Ln 1	nnn.n dB
R 39	_LN2	Ln 2	nnn.n dB
R 40	_LN3	Ln 3	nnn.n dB
R 41	_LN4	Ln 4	nnn.n dB
R 42	_LN5	Ln 5	nnn.n dB
R 43	_LN6	Ln 6	nnn.n dB
R 44	_O.DOSE	Overall Dose	nnnnn.n%
R 45	_C.DOSE	Current Dose	nnnnn.n%
R 46	_O.PROJ	Overall Projected Dose	nnnnn.n%
R 47	_C.PROJ	Current Projected Dose	nnnnn.n%
R 48	_LDLDOSE	LDL Dose	nnnnn.n%
R 49	_LDLPROJ	LDL Projected Dose	nnnnn.n%
R 50	_LDLLINT	LDL Lint	nnn.n dB
R 51	_LDLSEL	LDL SEL	nnn.n dB
R 52	_LDLXR	LDL Exchange Rate Text	cccccc
R 53	_LDLVALID	LDL Valid display (see note below)	cccccc
R 54	_RELLVL	Last Level Relative to REFLVL	-nnn.n
R 55	_TABLE	Display Histogram Selected	ccc
R 56	_COUNT	Display Overall Count	nnnnnk
R 57	_O.LEQ	Overall Leq	nnn.n dB
R 58	_D.LEQ	Daily Leq	nnn.n dB
R 59	_H.LEQ	Hourly Leq	nnn.n dB
R 60,h	_HNL	Hourly Leq 0-23	nnn.n dB
R 61,h	_HNLPART	Hourly Leq partial indicator nnn.n dB	
R 62	_O.LDN	Overall LDN	nnn.n dB
R 63	_D.LDN	Daily LDN	nnn.n dB
R 64	_H.LDN	Hourly LDN	nnn.n dB
R 65	_O.CNEL	Overall CNEL	nnn.n dB
R 66	_D.CNEL	Daily CNEL	nnn.n dB
R 67	_H.CNEL	Hourly CNEL	nnn.n dB

NOTE: An LDL (Logged Data Logic) recalculation can be started with a `_LDLVALID` I/O Read Command. When the Model 812 is RUNNING the Valid condition will remain in effect for 1 second. The `_LDLVALID` Read Command provides three responses, LDL Valid, Calculating, and LDL Invalid.

NOTE: The exceedance Leq, R68, and exceedance time, R69, include data from qualified events that are stored in the EXCD History. If an event is discarded because it was shorter than the minimum duration then it will not be included in these values.

R 70	<code>_BGLEQ</code>	Background Leq	nnn.n dB
R 71-85	<code>_unused</code>	unused variable	
R 86	<code>_BATT</code>	Battery Level	nnn%
R 87	<code>_BATTSRC</code>	Battery Source (INT/EXT)	ccc
R 88	<code>_TEMP</code>	Temperature	-nnn.n
R 89	<code>_SERNUM</code>	Serial Number	cccc
R 90	<code>_REVNUM</code>	Software Rev. & Rev. Date	n.nnn ddmmyyyy
R 91	<code>_FREEMEM</code>	Free Memory	nnnnnnn
R 92	<code>_RECLOG</code>	Number of RUN/STOP Records	nnnnn
R 94	<code>_RECINTV</code>	Number of INTV Records	nnnnn
R 95	<code>_RECHIST</code>	Number of HIST Records	nnnnn
R 97	<code>_RECCAL</code>	Number of Daily Records	nnnnn
R 98,n	<code>_ERRMSG</code>	Error Message List	cccccccccccccccccc(n) is the error list number, 1-8, 1 being latest error, or nnn, nnn...nnn if n=0 or omitted then the 8 error codes are output as number.
R 99	<code>_LOGIC1</code>	Logic Output 1 State	{On/Off} unused
R 100	<code>_LOGIC2</code>	Logic Output 2 State	{On/Off} unused
R 101	<code>_REPORT</code>	Report Number	nnnnn
R 102	<code>_PAGE</code>	Page Number	nnnnn
R 103	<code>_PRNLINE</code>	Printer Line Number	nnn
R 104	<code>_CALTIME</code>	Calibration Date/Time	ddmmyy hh:mm:ss
R 105	<code>_CHKTIME</code>	Cal Check Date/Time	ddmmyy hh:mm:ss
R 106	<code>_OFFSET</code>	Cal Offset	nnn.n
R 107	<code>_CHKLVL</code>	Cal check Level	nnn.n + OFFSET
R 108	<code>_RMSEX</code>	RMS Exceedance Flag 1	*

R 109	_RMSEX2	RMS Exceedance Flag 2	*
R 110	_PKEX	PEAK Exceedance Flag	*
R 111	_UWPKEX	UWPK Exceedance Flag	*
R 112	_OVLD	System Overload Flag	*
R 113	_EXXR	Excd Exchange Rate Text	cccc
R 114	_IVXR	Intv Exchange Rate Text	cccc
R 115	_AUTOADV	Auto-Advance History Ind.	+
R 116-131	_unused	unused variable	
R 137	_ALMTIM	Next Alarm Time	hh:mm
R 138	_IVTIME	Interval Date and Time of Occurrence	ddmmmyy hh:mm:ss
R 139	_IVDUR	Interval Duration	hh:mm:ss / mm:ss:ss
R 140	_IVLINT	Interval Lint	nnn.n dB
R 141	_IVSEL	Interval SEL	nnn.n dB
R 142	_IVMAX	Interval Lmin	nnn.n dB
R 143	_IVMIN	Interval Lmax	nnn.n dB
R 144	_IVPEAK	Interval Lpeak	nnn.n dB
R 145	_IVUWPK	Interval UnWeighted Peak	nnn.n dB
R 146	_HISTLEQ	AUTO-SEND HISTORY LEQ	nnn.n dB
R 147-149	_unused	unused variable	
R 150	_RUNCNT	Number of RUNS & CONTINUES	nnnnn
R 151	_POFAULT	Power On Fault Cause Character	c D Data Checksum Corrupt E EEPROM Checksum Corrupt K Key Reset (4+ RESET+ 1+ On) P Parameter Checksum Corrupt O Opcode Error R RAM Setup Register Corrupt T Test Memory Corrupt W Watchdog Reset

*An indicator has been added to the ON display on the top line of the 812's display to show faults that were detected by the power on test procedure. The R151 command will display the fault character to a computer. The indicators are:*

R 152	_INRMS	Internal RMS detector level	nnn.nn dB
R 153	_INPEAK	Internal PEAK detector level	nnn.nn dB

R 154	_INUWPK	Internal UwPk detector level	nnn.nn dB
R 155	_KEYCNT	Free Bytes in Keyboard Stack	nnn <sup>a</sup>
R 156	_BGTIM	Background Leq Time	hhhhh:mm:ss.ss
R 157	_CALSTAT	Calibration Status	<<UnStable>>
R 158	_MEMSIZ	Total number of bytes for histories	nnnnnnn
R 159	_MEMUSE	Memory Available in percent	nnn.nn
R 160	_O.OVLD	OVERALL OVERLOAD FLAG	c
R 161	_unused	unused variable	
R 162	_O.SE	Overall Sound Exposure	nnnnn.n P <sup>2</sup> H

a. The number of keys in the keyboard stack is available with the R155 command. This is used with keyboard simulation to prevent the loss of keys.

## Other Read Commands

---

Sound Exposure (E) is calculated and displayed in pascal squared hours as needed in some of the European Countries. This value is read with the R162 command and is available in the top line of the DOSE-a display. The formula used is:

$$E = T \cdot (10^{(Leq/10)}) \cdot 20\mu Pa^2,$$

where E is the Exposure, T is the elapsed time in hours, and  $20\mu Pa^2$  is the reference sound pressure 20 micro pascal squared.

R 163	_TAKT3	Takt Maximal 3 Second	nnn.n dB
R 164	_TAKT5	Takt Maximal 5 Second	nnn.n dB

## Group Read Programming

Code	Description	Response
O 1	Read SLM data	nnn.n, nnn.n, nnn.n, nnn.n<CR><LF> R 4 (SPL), R 11 (TWA), R 17, (Lmin), R 21 (Lmax)<CR><LF>
O 2	_unused	unused variable
O 3	Read Group of "R" variables programmed by G n,r	
O 4	Read 812's LCD Display, each line separated by <LF>	

The group read command G0 and the O[ther]3 command return the values of a list of up to 8 read variables previously defined by the programmer.

Syntax	Response
G0 or O3 cr	values of variables, separated by commas

In order to define the variables read by group read commands, use the following command for each desired read variable.

Syntax	Response
G[roup]n, var_no cr	lf

Where n is from 1 to 8, indicating the group list index and var\_no is the number of the "R" variable associated with the index. Use var\_no of "0" to define the last group list index when n<8.

### Example

G1, 4 cr	assigns the current SPL to the first group index
G2, 15 cr	assigns Lmin to the second index
G3, 19 cr	assigns Lmax to the third index
G4, 0 cr	terminates group command programming

After programming this group read list, the response to G0 is 59.5, 38.6, 102.2, the SPL,  $L_{\min}$  and  $L_{\max}$ .

## Setting Parameters

---

All commands begin with S. See Chapter 8 for a list of all the parameters and their settings. Note that the parameter numbers are for both Set (S) and Query (Q) commands. There are four types of parameters:

- Numeric
- Indexed
- Character strings
- Template

Brackets indicate optional characters and operands.

cr = carriage return; lf = line feed; \_ = space

### Numeric Parameters

Syntax	Response
S[et]item_number, parameter_valuecr	lf

Example:

S62, 120 sets RMS Excd Level 2 to 120.
--

### Indexed Parameters

Indexed parameters can be set in two ways: a. index number and b. actual indexed parameter value.

a. Index Number

Syntax	Response
S[et]item_number,index_number cr	lf

Example:

S9, 3 sets parameter 9:Baud Rate to third possible value of 2400.
S66, 1 sets Excd History Enable to Yes.
S84, 0 sets Hist Period Units to _1/32s
S84, 1 sets Hist Period Units to _1.0s

### b.Index Parameter Text

Indexed parameter texts must be preceded by a semicolon and enclosed by brackets. Indexed parameter texts must include the maximum number of characters, including spaces, which are indicated below with “\_”. This command may be used with flag 2 of the query command, which automatically encloses the parameter and required spaces in brackets.

Syntax	Response
S[et]item_number; [indexed_parameter_text] cr	lf

Examples:

S9; [_2400]	sets Baud Rate to 2400.
S66; [Yes]	sets Excd History Enable to Yes.
S84; [_1/32s]	sets Hist Period Units to 1/32s
S84; [_1.0s]	sets Hist Period Units to 1.0s

### Character String Parameters

To include leading spaces in a character string parameter, precede the character string with a “`” (leading single quote or grave accent, ASCII 9610 or 6016).

Syntax	Response
S[et]item_number; `character_string cr	lf



Example:

S2;` ABC Acoustics	sets Name to ABC Acoustics.
--------------------	-----------------------------

## Template Parameters

### \_Date

The month, day, and year are entered in that order and are separated by "/". The display shows day, month(abbreviated), and year in that order.

Syntax	Response
S[et]item_number; mm/dd/yy cr	If

Example:

S22, 05/23/89	sets Timer Run Date to 23May1989.
---------------	-----------------------------------

### \_Time

The hour, minutes, and seconds are entered in that order and are separated by ":". Military (24 hour clock) time is used: i.e. add 12 to afternoon hours.

Syntax	Response
S[et]item_number; hh:mm:ss cr	If

Example:

S24, 14:25:33 sets Timer Run Time 1 to 14:25:33.
--

## Query Parameters

---

All these commands begin with Q. Brackets indicate optional characters and operands. See Chapter on SETUP for a list of all the parameters and their settings.  
 cr = carriage return; lf = line feed; \_ = space

Syntax	Response
Q[query]item_number[,flag]	Depends on flag

Option flags elicit the following responses:

Flag	Response
none	Current parameter
1	Parameter name and current setting
2	Current parameter setting (including spaces) in brackets or parentheses
3	Parameter name and current setting (including spaces) in brackets or parentheses
32	Index number for indexed parameter

Flag values may be added together for desired combinations:

Example:	Response
1.Q66	No
2.Q66, 1	Excd History Enable=No
3.Q66, 2	[_No]
4.Q66, 32	0
5.Q66, 3	Excd History Enable=[_No]

Responses are denoted by (x) if Yes/No or (n) if numerical.

Command	Variable	Description	Comment
Q 1	Q.RESALL	RESET-ALL	
Q 2	Q.HDG1	HEADING LINE #1	
Q 3	Q.HDG2	HEADING LINE #2	

Q 4	Q.HDG3	HEADING LINE #3	
Q 5	Q.TITLE	MEASUREMENT TITLE	
Q 6	Q.TIME	CURRENT TIME	
Q 7	Q.DATE	CURRENT DATE	
Q 8	Q.DAY	DAY OF WEEK	
Q 9	Q.BAUD	COM1 BAUD RATE	
Q 10	Q.SADDR	COM1 ADDRESS	
Q 11	Q.NI	RESERVED PARAMETER	
Q 12	Q.HS	COM PORT HANDSHAKING REGISTER	
Q 13	Q.NI	RESERVED PARAMETER	
Q 14	Q.LOGIC1	OUTPUT 1 LOGIC	unused
Q 15	Q.OUT1TIM	OUTPUT 1 HOLD TIME	unused
Q 16	Q.LOGIC2	OUTPUT 2 LOGIC	
Q 17 M	Q.OUT2TI	OUTPUT 2 HOLD TIME	unused
Q 18	Q.HALT	HALT LINE MODE	Halt Line Mode Q18 has a [None] state available. This allows systems with intrusion alarm hardware to be disabled during servicing. The choices are: [None   Pause   Toggle   Level   Alarm].

Q 19	Q.BEEP	BEEP WHILE RUNNING	unused
Q 20	Q.PWRSV	POWER SAVE OPTIONS	
Q 21	Q.TIMMD	TIMER MODE	
Q 22	Q.RUND	TIMER RUN DATE	
Q 23	Q.STOPD	TIMER STOP DATE	
Q 24	Q.RUNT1	TIMER RUN TIME 1	
Q 25	Q.STOPT1	TIMER STOP TIME 1	
Q 26	Q.RUNT2	TIMER RUN TIME 2	
Q 27	Q.STOPT2	TIMER STOP TIME 2	
Q 28	Q.LKCOMB	LOCK COMBINATION	
Q 29	Q.LKRS	LOCK R/S KEY	
Q 30	Q.LKSU	LOCK SETUP	

Q 31	Q.LKFN	LOCK FUNCTION	
Q 32	Q.LKRES	LOCK RESET	
Q 33	Q.LKPWR	LOCK THE 'ON' KEY	
Q 34	Q.LKIO	LOCK I/O	
Q 35	Q.CALLVL	CAL LEVEL	
Q 36	Q.CALSN	CALIBRATOR S/N	
Q 37	Q.AUTOCAL	AUTO-CALIBRATION MODE	
Q 38	Q.CALTIM	AUTO CAL TIME	
Q 39	Q.DETC	DETECTOR	
Q 40	Q.WGHT	FREQUENCY WEIGHTING	
Q 41	Q.HPASS	HIGH PASS FILTER	unused
Q 42	Q.LPASS	LOW PASS FILTER	unused
Q 43	Q.MICV	MIC POLARIZATION	unused
Q 44	Q.REFLVL	RELATIVE LEVEL REFERANCE	
Q 45	Q.CXRATE	CURRENT EXCHANGE RATE	
Q 46	Q.CTHOLD	CURRENT THRESHOLD	
Q 47	Q.CCRIT	CURRENT CRITERION	
Q 48	Q.OXRATE	OVERALL EXCHANGE RATE	
Q 49	Q.OTHOLD	OVERALL THRESHOLD	
Q 50	Q.OCRIT	OVERALL CRITERION	
Q 51	Q.DOSET	DOSE PERIOD	
Q 52	Q.LDLXRATE	LDL EXCHANGE RATE	
Q 53	Q.LDLTHOLD	LDL THRESHOLD	
Q 54	Q.LDLCRIT	LDL CRITERION	
Q 55	Q.LNN1	Lnn 1 PERCENT	
Q 56	Q.LNN2	Lnn 2 PERCENT	
Q 57	Q.LNN3	Lnn 3 PERCENT	
Q 58	Q.LNN4	Lnn 4 PERCENT	
Q 59	Q.LNN5	Lnn 5 PERCENT	
Q 60	Q.LNN6	Lnn 6 PERCENT	
Q 61	Q.RMSTH1	RMS EXCD LEVEL 1	

Q 62	Q.RMSTH2	RMS EXCD LEVEL 2	
Q 63	Q.PKTH	PEAK EXCD LEVEL	
Q 64	Q.UWTH	UWPK EXCD LEVEL	
Q 65	Q.HYST	EXCD HYSTERESIS	
Q 66	Q.EXENB	ENABLE EXCD HISTORY	
Q 67	Q.EXXRT	EXCD EXCHANGE RATE	
Q 68	Q.EXMIN	EXCD MINIMUM DURATION	
Q 69	Q.EXHENB	EXCD TIME-HIST ENABLE	
Q 70	Q.EXPER	EXCD TIME-HIST PERIOD	
Q 71	Q.EXADEN	EXCD SAVE A:D ENABLE	unused
Q 72	Q.IVENB	ENABLE INTV HISTORY	
Q 73	Q.IVXRT	INTV EXCHANGE RATE	
Q 74	Q.IVTHOLD	INTV THRESHOLD	
Q 75	Q.IVPER	INTV PERIOD	
Q 76	Q.IVSYNC	INTV TIME SYNC	
Q 77	Q.IVLN	INTV SAVE Ln'S	
Q 78	Q.IVADEN	INTV SAVE A:D	unused
Q 79	Q.IVSTOP	INTV AUTO STOP	
Q 80	Q.HSTENB	ENABLE TIME HIST	
Q 81	Q.HSTRES	HIST RESOLUTION	
Q 82	Q.HSTPK	HIST SAVE PEAK	
Q 83	Q.HSTPER	HIST PERIOD	
Q 84	Q.HSTUNIT	HIST PERIOD UNITS	
Q 85	Q.HSTBASE	HIST BASE	
Q 86	Q.HSTMODE	HIST BASE MODE	
Q 87	Q.HGRES	HISTOGRAM TABLE RESOLUTION	
Q 88	Q.DYENB	ENABLE DAILY LDN HISTORY	
Q 89	Q.PRNRP	DATA REPORT	(x)
Q 90	Q.PRNLOG	R/S AND CAL LOG	(x)
Q 91	Q.PRN...	SETUP REPORT	(x)

## Histogram Reports

The RMS, Peak and UWPK histogram reports have been implemented with this revision. The unformatted reports have also been developed and the format is the level of the first bin followed by the number of samples in each bin (in hex, 0-9 & a-). There are 1024 RMS bins and 128 Peak and UWPK bins, this corresponds to 1/8th dB resolution for RMS and 1dB resolution for the peak tables.

Q 92	Q.PRN...	RMS HISTOGRAM TABLE	(x)
Q 93	Q.PRN...	RMS HISTOGRAM TABLE LOW VALUE	(n)
Q 94	Q.PRN...	RMS HISTOGRAM TABLE HI VALUE	(n)
Q 95	Q.PRN...	RMS HISTOGRAM TABLE RESOLUTION	(x)
Q 96	Q.PRN...	PEAK HISTOGRAM TABLE	(x)
Q 97	Q.PRN...	PEAK HISTOGRAM TABLE LOW VALUE	(n)
Q 98	Q.PRN...	PEAK HISTOGRAM TABLE HI VALUE	(n)
Q 99	Q.PRN...	PEAK HISTOGRAM TABLE RESOL	(x)
Q 100	Q.PRN...	UWPK HISTOGRAM TABLE	(x)
Q 101	Q.PRN...	UWPK HISTOGRAM TABLE LOW VALUE	(n)
Q 102	Q.PRN...	UWPK HISTOGRAM TABLE HI VALUE	(n)
Q 103	Q.PRN...	UWPK HISTOGRAM TABLE RESOL	(x)

### Tailored Report

Q 104	Q.PRN...	EXCD REPORT	(x)
Q 105	Q.PRN...	EXCD REPORT LOW RECORD	(n)
Q 106	Q.PRN...	EXCD REPORT HIGH RECORD	(n)
Q 107	Q.PRN...	INTV REPORT	(x)
Q 108	Q.PRN...	INTV REPORT LOW RECORD	(n)
Q 109	Q.PRN...	INTV REPORT HIGH RECORD	(n)
Q 110	Q.PRN...	HIST REPORT	(x)
Q 111	Q.PRN...	HIST REPORT LOW RECORD	(n)
Q 112	Q.PRN...	HIST REPORT HIGH RECORD	(n)
Q 113	Q.PRN...	DAILY NOISE REPORT	(x)
Q 114-120		RESERVED PARAMETER 18-24 respectively	

Q 121-150 Reserved

Miscellaneous

Q 151	Q.AUTOLEQ	AUTO-SEND HISTORY LEQ TO PRN	unused
Q 152	Q.EAON	ELECTROSTATIC ACTUATOR OFF/ON	
Q 153	Q.HEATER	HEATER LINE OFF/ON	unused
Q 154	Q.MDMMD	MODEM MODE	(x)
Q 155	Q.DIAL	MODEM DIAL OUT MODE	(x)
Q 156	Q.PHONE	MODEM PHONE NUMBER (30 char)	
Q 157	Q.MONNUM	Monitor Number	(nnn)
Q 158	Q.MDMI	MODEM INIT STRING (30 char)	
Q 159	Q.PWRMD	POWER MODE	[Normal Ext CO]
Q 160	Q.PWRCO	EXTERNAL POWER CUT OFF VOLTAGE	
Q 161	Q.TMEXPR	TIMED EXCD PERIOD	

Special Functions - Advanced use only. Remaining commands are not available on SETUP menu.

Q 162-167	Q.NI18-23	RESERVED PARAMETER 18-23	
Q 168	Q.RTEXCD	REAL-TIME EXCD REPORT	(x)
Q 169	Q.RTINTV	REAL-TIME INTV REPORT	(x)
Q 170	Q.RTHIST	REAL-TIME HIST REPORT	(x)
Q 171	Q.RTLOG	REAL-TIME RUN-LOG RPT	(x)
Q 172	Q.RTDAY	REAL-TIME DAILY REPORT	(x)
Q 173	Q.RTCAL	REAL-TIME CAL REPORT	(x)
Q 174	Q.RTFRMT	UNFORMATTED REPORTS	(x)
Q 175	Q.RPTBEG	Begin Printing	(x)
Q 176	Q.PTYPE	PRINTER TYPE	(x)
Q 177	Q.RPT	DATA REPORT	(x)
Q 178	Q.RPT---	R/S AND CAL LOG	(x)
Q 179	Q.RPT---	SETUP REPORT	(x)
Q 180	Q.RPT---	RMS HISTOGRAM TABLE	(x)
Q 181	Q.RMSLO	RMS HISTOGRAM TABLE LOW VALUE	(n)
Q 182	Q.RMSHI	RMS HISTOGRAM TABLE HI VALUE	(n)

Q 183	Q.RMSRS	RMS HISTOGRAM TABLE RESOLUTION	(x)
Q 184	Q.RPT--	PEAK HISTOGRAM TABLE	(x)
Q 185	Q.RPT--	PEAK HISTOGRAM TABLE LOW VALUE	(n)
Q 186	Q.RPT--	PEAK HISTOGRAM TABLE HI VALUE	(n)
Q 187	Q.RPT--	PEAK HISTOGRAM TABLE RESOL	(x)
Q 188	Q.RPT--	UWPK HISTOGRAM TABLE	(x)
Q 189	Q.RPT--	UWPK HISTOGRAM TABLE LOW VALUE	(n)
Q 190	Q.RPT--	UWPK HISTOGRAM TABLE HI VALUE	(n)
Q 191	Q.RPT--	UWPK HISTOGRAM TABLE RESOL	(x)
Q 192	Q.RPT--	EXCD REPORT	(x)
Q 193	Q.RPT--	EXCD REPORT LOW RECORD	(n)
Q 194	Q.RPT--	EXCD REPORT HIGH RECORD	(n)
Q 195	Q.RPT--	INTV REPORT	(x)
Q 196	Q.RPT--	INTV REPORT LOW RECORD	(n)
Q 197	Q.RPT--	INTV REPORT HIGH RECORD	(n)
Q 198	Q.RPT--	HIST REPORT	(x)
Q 199	Q.RPT--	HIST REPORT LOW RECORD	(n)
Q 200	Q.RPT--	HIST REPORT HIGH RECORD	(n)
Q 201	Q.RPTEND	DAILY NOISE REPORT	(x)
Q 202	Q.CALMODE	CALIBRATION MODE	
Q 203	Q.ULCOMB	UNLOCK COMBINATION(ccccccc)	
Q 204	Q.IONAME	I/O FILENAME(ccccccc)	
Q 205	Q.ERCHK	ENABLE ERROR CHECKING I/O	



## Error Checking I/O

The error checking I/O protocol verifies that commands and data are transferred without errors.

- To enable error checking the @ command or S205,1 command is used.
- To disable error checking two <CR> characters in a row may be sent (if not in the Modem Mode) or the S205, 0F command is sent.

The “F” is the check character for the S205, 0 command. A detailed description of the protocol is available from Larson Davis and the latest revisions of software utilize the protocol.

Q 206	Q.TBLMODE	Ln table mode	[Overall  Daily]
Q 207	Q.NFLVL	NOISE FLOOR LEVEL	

This parameter is set to the noise floor of the instrument so that it can properly indicate “Near Noise Floor” messages when within 10dB of the noise floor. It is also used with NF Compensate, Q208, which will place the Model 812 in an extended Linearity Range Mode. The true noise floor of the entire system must be measured and entered in Q207. This will vary with the selected input weighting or microphone sensitivity. An equivalent microphone capacitance can be used after calibration to determine the noise floor. It may also be possible to remove the microphone bias to obtain this value. When properly set up the linearity range can be increased by 10dB.

*NOTE: The mode is always turned off with a CAL Change.*

Q 208	Q.NFMODE	NOISE FLOOR COMP MODE	
Q 209	Q.875MD	875 RTA MODE [None Excd Intv Dual]	unused
Q 210	Q.CNTLREG	AUX CONTROL REG	
Q 211	Q.EXREC	EXCD RECORD NUMBER	
Q 212	Q.IVREC	INTV RECORD NUMBER	
Q 213	Q.HSTREC	HIST RECORD NUMBER	
Q 214	Q.LOGREC	RUN-LOG RECORD NUMBER	

Q 215	Q.DYREC	DAILY RECORD NUMBER	
Q 216	Q.CALREC	CALIBRATION RECORD NUMBER	
Q 217	Q.TBLLVL	LOCATE HISTOGRAM TABLE LEVEL	
Q 218-225	Q.NI42-Q.N149	RESERVED PARAMETER 42-49 respectively	
Q 226	Q.OVLDLVL	OVERLOAD LEVEL	
Q 227	Q.RMSOS	RMS CALIBRATION OFFSET	
Q 228	Q.PKOS	PEAK TO RMS CAL OFFSET	
Q 229	Q.UWPKOS	UwPk TO RMS CAL OFFSET	
Q 230-231	Q.NI51-Q.N152	RESERVED PARAMETER 51-52	
Q 232	Q.TEMP	ENTER CURRENT TEMPERATURE	
Q 233	Q.SERNUM	ENTER SERIAL NUMBER	

## History Records

---

The various histories of the Model 812 are accessed in a similar fashion. After using a direct index to the correct record, one can advance or back up a certain number of records to the new value to be read.

Brackets in the syntax indicate optional characters and operands.

cr = carriage return; lf = line feed

### Types of History

Denoted in syntax by history\_no:

1=Exceedance (E)

2=Interval (I)

3=Daily (D)

4=Run Log (L)

5=Calibration (C)

6=Time (H)

7=Histogram Table (T)

### Advance

Advance a number of records from present record number.

If no num\_record (number of records) is provided, 1 is assumed.

Syntax	Response
A[dvance][num_record][, history_no] cr	lf

Example:

A9, 5 (current record is 17): calibration history(s) record 26 (17+9) is located.
---

## Backup

Backup a number of records from present record number.

Syntax	Response
[Backup][num_record][, history_no] cr	If

If no num\_record (number of records) is provided, 1 is assumed.

Example:

B9, 5 (current record is 17): locates calibration history record 8 (17-9).

## Find

Find record number directly.

Syntax	Response
F[ind]rec_no[, history_no] cr	If

Example:

F9,5: locates calibration history record 9
--

Generally one uses the Find command to get to the first record (F1,2) and the Advance command (A) to move up through the records.

## History Data Variables

---

### Interval History Variables

Brackets in the syntax indicate optional characters and operands.

Syntax	Response
I[interval]var_noIntv_var	

Example:

I9, -5 (current record is 17)

RMS Exceedance count in record 12.

Example:

I9, 5 (current record is 17)

RMS Exceedance count in record 22

I 1	Date and Time of Occurrence	ddmmmyy hh:mm:ss	
I 2	Duration	hh:mm:ss / mm:ss.ss	
I 3	Lint	nnn.n dB	
I 4	SEL		nnn.n dB
I 5	Lmin		nnn.n dB
I 6	Lmax		nnn.n dB
I 7	Lpeak		nnn.n dB
I 8	UnWeighted Peak	nnn.n dB	
I 9	RMS Exceedance Count	nnn	
I 10	Peak Exceedance Count	nnn	
I 11	UnWeighted Peak Excd Count	nnn	
I 12	Overload Counts	nnn	
I 13	nn 1		Lnn
I 14	Ln 1		nnn.n dB
I 15	nn 2		Lnn
I 16	Ln 2		nnn.n dB
I 17	nn 3		Lnn
I 18	Ln 3		nnn.n dB
I 19	nn 4		Lnn
I 20	Ln 4		nnn.n dB
I 21	nn 5		Lnn
I 22	Ln 5		nnn.n dB

I 23	nn 6		Lnn
I 24	Ln 6		nnn.n dB
I 101	Intv Variables 1-24	Macro	

## Run Log Variables

Brackets in the syntax indicate optional characters and operands.

Syntax	Response
L[og]var_nolog_var	
Example: L1	Run/Stop number

L 1	Run/Stop Number	nnnnn
L 2	Run/Stop Type	{RUN/STOP/CONT/PAUSE/MARK}
L 3	Cause	{TIMER/KEY/A:D-n/HALT/INTV/BATT}
L 4	Day, Date and Time	ddd ddmmmyyyy hh:mm:ss
L 101	Run-Log Variables L1-L4	all variable values

## Calibration History Variables

Brackets in the syntax indicate optional characters.

Syntax	Response
C[alibration]var_no	cal_var

Example:

C1	checked level
----	---------------

C 1	Checked Level	nnn.n
C 2	Day, Date and Time	ddd ddmmmyyyy hh:mm:ss
C 3	Calibration Mode	[Manual/Auto]
C 4	Cal Status	[OK/Bad]

C 101	Cal Variables 1-4	all variable values
-------	-------------------	---------------------

### Time History Variables

Brackets in the syntax indicate optional characters and operands.

Syntax	Response
H[istory]var_no	time_var

Example:

H2	Peak level in current record
----	------------------------------

H 1	RMS Level	nnn.n dB
H 2	Peak Level	nnn.n dB
H 3	Run Time of Sample (calc)	hhhh:mm/mm:ss/ss
H 4	HISTORY BARGRAPH	=====

### Histogram Table Variables

Brackets in the syntax indicate optional characters and operands.

Table:

- 1=RMS,
- 2=Peak,
- 3=Unweighted Peak.

Default is last used table or RMS.

Syntax	Response
T[table]var_no[, table]	table_var

Example:

T1,1	RMS current bin level
------	-----------------------

T 1,n <sup>a</sup>	Level of current bin	nnn.n dB
T 2,n	Count of samples	nnnnnc (c= K or M for Kilo or Mega)
T 3,n	Percent of total	nnn.nn%
T 5 [, n]	Prints the accumulated timer for the current level/bin. The table number is optional.	hhhh:mm:ss.s

a. Where n equals the table number: 1-RMS, 2-Peak, & 3-UnWeighted Peak.

## Print Commands

Brackets in the syntax indicate optional characters.

cr = carriage return; lf = line feed

Syntax	Response
P[rint]print_no cr	lf

Example:

P1 cr	lf
-------	----

Example:

P9cr S177,1cr S178,1cr S192,1cr P100cr	(1) sets all report enables in setup to [No] (2) sets the Data report, Run-log, and EXCD report enables (short) to [Yes] and (3) begins printing to the computer
--	--

Syntax	Description
P 0	Standard Report (Formatted from normal setup parameters)
P 1	Data Report
P 2	Data & Histograms
P 3	Short Full Report (Histories with SHORT option)



P 4	Long Full Report (Histories with LONG option)
P 9	All Report Enables Turned OFF
P 100	Begin Printing a Report
P 101	Begin Printing using RXD as Hardware Handshake flow control
P 999	Abort Printing
X 100	XMODEM Begin Printing (same as P100 except through the XMODEM communication protocol)
^X^X	CANcel transfer mode, 2 in a row (ASCII <CAN> or CHR\$(24))

## Error Messages and Warnings

---

The code listed is the number provided by R98.

All error messages begin with: CHR\$(7), "ERROR - "

Error Code	Message
1	"COUNT OVERFLOW"
2	"EXPONENTIAL OVERFLOW"
3	"RTX TASK SELECT"
4	"ILLEGAL EXCHANGE RATE"
5	"UNKNOWN INTERRUPT"
6	"WATCHDOG RESET"
7	"OPCODE ERROR"

All warning messages begin with: CHR\$(7), "WARNING - "

Add 128 to these numbers to get the actual warning number.

Warning Code	Message
128	"Out of Memory"
129	"Battery Low"
130	"POWER FAILURE"
131	"DIVISION BY ZERO"

132	“Operand-1 Range”
133	“Operand-2 Range”
134	“DPC Format”
135	“Key Has No Effect”
136	“Stop Required”
137	“Key Has No Effect In “VIEW””
138	“Parameter Entered Wrong”
139	“RESET-ALL Required”
140	“Use ARROWS, (ON) to Exit”
141	“Use NEXT/PREV or ENTER”
142	“Invalid Numeric Entry”
143	“OPEN #”
144	“Already Open”
145	“No History Yet”
146	“At End of History”
147	“At Start of History”
148	“History Format Error”
149	“Unknown I/O Command”
150	“I/O Operand Invalid”
151	“Unable to Calibrate”
152	“EEPROM Write Error”
153	“Memory was Lost, Data Reset!”
154	“RECALL- Not Found”
155	“Function Not Implemented”
156	“System Locked”
157	“A:D Stack Full”
158	“A:D Over-Run”
159	“Serial Port Framing”
160	“Serial Port Line Noisy”
161	“Serial Port Over-Run”
162	“Wait for Stabilization”

163	“Power Turned Off”
164	“Time/Date Not Set!”
165	“Printer Already BUSY”
166	“Lithium Battery Low”
167	“Timer ON Pending”



## C

## Glossary

This appendix contains technical definitions of key acoustical and vibration terms commonly used with Larson Davis instruments. The reader is referred to American National Standards Institute document S1.1-1994 for additional definitions. Specific use of the terms defined are in the main body of the text.

**Allowed Exposure Time ( $T_i$ )** It is the allowed time of exposure to sound of a constant A-weighted sound level given a chosen Criterion Level, Criterion Duration, and Exchange Rate. The equation for it is

$$T_i = \frac{T_c}{2^{(L_{avg} - L_c)/Q}} = \frac{T_c}{10^{(L_{avg} - L_c)/q}}$$

where  $L_c$  is the Criterion Level,  $T_c$  is the Criterion Duration,  $Q$  is the Exchange Rate,  $K$  is the Exchange Rate Factor and  $L_{avg}$  is the Average Sound Level.

*Example:* If  $L_c = 90$ ,  $T_c = 8$ ,  $Q = 3$  and  $L_i = 95$  then

$$T_i = \frac{8}{10^{(95-90)/10}} = \frac{8}{2^{(95-90)/3}} = 5.656 = 5 \text{ hours and } 39 \text{ minutes}$$

This means that if a person is in this area for 5 hours and 39 minutes he will have accumulated a Noise Dose of 100%.

*Standard:* ANSI S12.19

**Average Sound Level ( $L_{avg}$ )** It is the logarithmic average of the sound during a Measurement Duration (specific time period), using the chosen Exchange Rate Factor. Exposure to this sound level over the period would result in the same noise dose and the actual

(unsteady) sound levels. If the Measurement Duration is the same as the Criterion Duration, then  $L_{avg}=L_{TWA(LC)}$

$$L_{avg} = q \text{Log}_{10} \left( \frac{1}{T} \int_{T_1}^{T_2} 10^{(L_p(t))/q} dt \right)$$

where the Measurement Duration (specified time period) is  $T=T_2-T_1$  and  $q$  is the Exchange Rate Factor. Only sound levels above the Threshold Level are included in the integral.  
*Standard: ANSI S12.19*

### Calibration

Adjustment of a sound or vibration measurement system so that it agrees with a reference sound or vibration source. It should be done before each set of measurements.

**Community Noise Equivalent Level (CNEL,  $L_{den}$ )** A rating of community noise exposure to all sources of sound that differentiates between daytime, evening and nighttime noise exposure. The equation for it is

$$L_{den} = 10 \log_{10} \left[ \sum_{0000}^{0700} 10^{(L_i+10)/10} + \sum_{0700}^{1900} 10^{L_i/10} + \sum_{1900}^{2200} 10^{(L_i+5)/10} + \sum_{2200}^{2400} 10^{(L_i+10)/10} \right]$$

The continuous equivalent sound level is generally calculated on an hourly basis and is shown in the equation as  $L$ . The levels for the hourly periods from midnight to 7 a.m. have 10 added to them to represent less tolerance for noise during sleeping hours. The same occurs from 10 p.m. to midnight. The levels for the hourly periods between 7 p.m. and 10 p.m. have 5 added to them to represent a lessened tolerance for noise during evening activities. They are energy summed and converted to an average noise exposure rating.

### Criterion Duration ( $T_c$ )

It is the time required for a constant sound level equal to the Criterion Level to produce a Noise Dose of 100%. Criterion Duration is typically 8 hours.

*Example: If the Criterion Level = 90 dB and the Criterion Duration is 8 hours, then a sound level of 90 dB for 8 hours,*

will produce a 100% Noise Dose. See Noise Dose.  
*Standard:* ANSI S12.19

**Criterion Sound Exposure (CSE)** The product of the Criterion Duration and the mean square sound pressure associated with the Criterion Sound Level when adjusted for the Exchange Rate. It is expressed in Pascals-squared seconds when the exchange rate is 3 dB. where q is the Exchange Rate Factor. See Exchange Rate.

$$CSE = T_c 10^{L_c/q}$$

*Standard:* ANSI S1.25

**Criterion Sound Level (L<sub>c</sub>)** It is the sound level which if continually applied for the Criterion Duration will produce a Noise Dose of 100%. The current OSHA Criterion Level is 90 dB.  
*Standard:* ANSI S12.19

**Daily Personal Noise Exposure (L<sub>EP,d</sub>)** It is the level of a constant sound over the Criterion Duration that contains the same sound energy as the actual, unsteady sound over a specific period. The period is generally shorter, so the sound energy is spread out over the Criterion Duration period.  
*Example:* If the Criterion Duration = 8 hours and the specific period is 4 hours and the average level during the 4 hours is 86 dB, then the L<sub>EP,d</sub> = 83 dB.

**Day-Night Average Sound Level (DNL, L<sub>dn</sub>)** A rating of community noise exposure to all sources of sound that differentiates between daytime and nighttime noise exposure. The equation for it is

$$L_{dn} = 10 \text{Log}_{10} \left[ \sum_{0000}^{0700} 10^{(L_i + 10)/10} + \sum_{0700}^{2200} 10^{L_i/10} + \sum_{2200}^{2400} 10^{(L_i + 10)/10} \right]$$

The continuous equivalent sound level (See definition) is generally calculated on an hourly basis and is shown in the equation as L. The values for the hourly periods from midnight to 7 a.m. have 10 added to them to represent less tolerance for noise during sleeping hours. The same occurs from 10 p.m. to midnight. They are energy summed and converted to an average noise exposure rating.

**Decibel (dB)** A logarithmic form of any measured physical quantity, typically used in sound and vibration measurements. Whenever

the word *level* is used it implies this logarithmic form. The relationship is relatively simple, but the mathematics can become complex. It is widely used and was developed so that the very wide range of any quantity could be represented more simply. It is not possible to directly add or subtract physical quantities when expressed in decibel form. The word level is always attached to a physical quantity when it is expressed in decibels; for example  $L_p$  represents the sound pressure level. The table below shows the actual value of a specific item, such as sound pressure, for which the level is to be determined. First the value is put into exponential form in powers of ten; the exponent is the Bel. The exponent is then multiplied by ten to yield the decibel. This procedure converts multiplication into addition; every time 10 is *added* to the level, the value is *multiplied* by 10. When the value is not an even multiple of ten the exponent is more complicated as shown in the table. Every time the level increases by 3 dB, the value is multiplied by 2 (doubled). These two rules are worth remembering.

Linear form		Level form
Ration of Value to Reference	Exponential Form of Ratio	10•Exponent
1	$10^0$	0
10	$10^1$	10
100	$10^2$	20
200	$10^{2.3}$	23
1000	$10^3$	30
10000	$10^4$	40
100000	$10^5$	50
1000000	$10^6$	60

The definition of decibel is intended for power-like quantities ( $W$ ). Sometimes power is represented by the square of a measured quantity and this results in a different form of the equation (See Sound Pressure Level).

$$L = 10 \text{Log}_{10} \left[ \frac{W}{W_0} \right] \quad W = W_0 10^{L/10}$$

The value of the item in the table is not the value of the quantity itself but the ratio of that quantity to a reference quantity. So for every level in decibels there must be a reference quantity. When the quantity equals the reference quantity



the level is zero. To keep the values above zero, the reference is generally set to be the lowest value of the quantity.

**Department of Defense Level ( $L_{DOD}$ )** The Average Sound Level calculated in accordance with Department of Defense Exchange Rate and Threshold Level. See Average Sound Level

**Dose** (See Noise Dose)

**Detector** The part of a sound level meter that converts the actual fluctuating sound or vibration signal from the microphone to one that indicates its amplitude. It first squares the signal, then averages it in accordance with the time-weighting characteristic, and then takes the square root. This results in an amplitude described as *rms* (root-mean-square).

**Eight Hour Time-Weighted Average Sound Level ( $L_{TWA(8)}$ )** It is the constant sound level that would expose a person to the same Noise Dose as the actual (unsteady) sound levels. The equation for it is

$$L_{TWA(8)} = L_c + q \text{Log}_{10} \left( \frac{D}{100} \right)$$

NOTE: This definition applies only for a Criterion Duration of 8 hours.

Standard: ANSI S12.19

**Energy Equivalent Sound Level ( $L_{eq}$ )** The level of a constant sound over a specific time period that has the same sound energy as the actual (unsteady) sound over the same period.

$$L_{eq} = 10 \text{Log}_{10} \left[ \frac{\int_{T_1}^{T_2} p^2(t) dt}{p_o^2 T} \right]$$

where  $p$  is the sound pressure and the Measurement Duration (specific time period)  $T=T_2-T_1$ . See Sound Exposure Level.

**Exchange Rate (Q), Exchange Rate Factor (q), Exposure Factor (k)** It is defined in ANSI S1.25 as “the change in sound level corresponding to a doubling or halving of the duration of a sound level while a constant percentage of criterion exposure is maintained.” The

rate and the factors are given in the table below.  
*Standard: ANSI S12.19*

Exchange Rate, Q	Exchange Rate Factor, q	Exposure Factor, k
3.01	10	1
4	13.333	.75
5	16.667	.60
6.02	20	.50

## Far Field

There are two types of far fields: the *acoustic* far field and the *geometric* far field.

*Acoustic Far Field:* The distance from a source of sound is greater than an acoustic wavelength. In the far field, the effect of the type of sound source is negligible. Since the wavelength varies with frequency (See the definition of Wavelength), the distance will vary with frequency. To be in the far field for all frequencies measured, the lowest frequency should be chosen for determining the distance. For example, if the lowest frequency is 20 Hz, the wavelength at normal temperatures is near 56 ft. (17 m); at 1000 Hz, the wavelength is near 1.1 ft. (1/3 m). See the definition of Acoustic Near Field for the advantages of in the acoustic far field.

*Geometric Far Field:* The distance from a source of sound is greater than the largest dimension of the sound source. In the far field, the effect of source geometry is negligible. Sound sources often have a variety of specific sources within them, such as exhaust and intake noise. When in the far field, the sources have all merged into one, so that measurements made even further away will be no different. See the definition of Geometric Near Field for the advantages of being in the geometric far field.

## Free Field

A sound field that is *free* of reflections. This does not mean that the sound is all coming from one direction as is often assumed, since the source of sound may be spatially extensive. See the definitions of near and far fields for more detail. This definition is often used in conjunction with reverberant field.

## Frequency (Hz, rad/sec)

The rate at which an oscillating signal completes a complete cycle by returning to the original value. It can be expressed in cycles per second and the value has the unit symbol Hz

(Hertz) added and the letter  $f$  is used for a universal descriptor. It can also be expressed in radians per second, which has no symbol, and the greek letter  $\omega$  is used for a universal descriptor. The two expressions are related through the expression  $\omega=2\pi f$ .

**Frequency Filter - Band Pass** The part of certain sound level meters that divides the frequency spectrum on the sound or vibration into a part that is unchanged and a part that is filtered out. It can be composed of one or more of the following types:

*Low Pass:* A frequency filter that permits signals to pass through that have frequencies below a certain fixed frequency, called a *cutoff frequency*. It is used to discriminate against higher frequencies.

*High Pass:* A frequency filter that permits signals to pass through that have frequencies above a certain fixed frequency, called a *cutoff frequency*. It is used to discriminate against lower frequencies.

*Bandpass:* A frequency filter that permits signals to pass through that have frequencies above a certain fixed frequency, called a lower cutoff frequency, and below a certain fixed frequency, called an *upper cutoff frequency*. The difference between the two cutoff frequencies is called the *bandwidth*. It is used to discriminate against both lower and higher frequencies so it passes only a band of frequencies.

*Octave band:* A bandpass frequency filter that permits signals to pass through that have a bandwidth based on octaves. An *octave* is a doubling of frequency so the upper cutoff frequency is twice the lower cutoff frequency. This filter is often further subdivided in 1/3 and 1/12 octaves (3 and 12 bands per octave) for finer frequency resolution. Instruments with these filters have a sufficient number of them to cover the usual range of frequencies encountered in sound and vibration measurements. The frequency chosen to describe the band is that of the center frequency. Note table in Frequency Filter - Frequency Weighting.

**Frequency Filter - Frequency Weighting** A special frequency filter that adjusts the amplitude of all parts of the frequency spectrum of the sound or vibration unlike band pass filters. It can be composed of one or more of the following types:

*A-Weighting*: A filter that adjusts the levels of a frequency spectrum in the same way the human ear does when exposed to low levels of sound. This weighting is most often used for evaluation of environmental sounds. See table below.

*B-Weighting*: A filter that adjusts the levels of a frequency spectrum in the same way the human ear does when exposed to higher levels of sound. This weighting is seldom used. See table below.

*C-Weighting*: A filter that adjusts the levels of a frequency spectrum in the same way the human ear does when exposed to high levels of sound. This weighting is most often used for evaluation of equipment sounds. See table below.

*Flat-Weighting*: A filter that does not adjust the levels of a frequency spectrum. It is usually an alternative selection for the frequency-weighting selection.

Center Frequencies, Hz		Weighting Network Frequency Response		
1/3 Octave	1 Octave	A	B	C
20		-50.4	-24.2	-6.2
25		-44.7	-20.4	-4.4
31.5	31.5	-39.4	-17.1	-3.0
40		-34.6	-14.2	-2.0
50		-30.2	-11.6	-1.3
63	63	-26.2	-9.3	-0.8
80		-22.5	-7.4	-0.5
100		-19.1	-5.6	-0.3
125	125	-16.1	-4.2	-0.2
160		-13.4	-3.0	-0.1
200		-10.9	-2.0	0
250	250	-8.6	-1.3	0
315		-6.6	-0.8	0
400		-4.8	-0.5	0
500	500	-3.2	-0.3	0
630		-1.9	-0.1	0
800		-0.8	0	0
1000	1000	0	0	0
1250		0.6	0	0
1600		1.0	0	-0.1
2000	2000	1.2	-0.1	-0.2
2500		1.3	-0.2	-0.3
3150		1.2	-0.4	-0.5
4000	4000	1.0	-0.7	-0.8
5000		0.5	-1.2	-1.3
6300		-0.1	-1.9	-2.0
8000	8000	-1.1	-2.9	-3.0
10000		-2.5	-4.3	-4.4
12500		-4.3	-6.1	-6.2
16000	16000	-6.6	-8.4	-8.5
20000		-9.3	-11.1	-11.2

<b>L<sub>eq</sub></b>	See “Energy Equivalent Sound Level”, “Sound Level”, “Energy Average”, and “Time Weighted Average”
<b>Level (dB)</b>	A descriptor of a measured physical quantity, typically used in sound and vibration measurements. It is attached to the name of the physical quantity to denote that it is a logarithmic measure of the quantity and not the quantity itself. The word <i>decibel</i> is often added after the number to express the same thing. When frequency weighting is used the annotation is often expressed as dB(A) or dB(B).
<b>Measurement Duration (T)</b>	The time period of measurement. It applies to hearing damage risk and is generally expressed in hours. <i>Standard: ANSI S12.19</i>
<b>Microphone Guidelines</b>	<p><b>Microphone - Types:</b> A device for detecting the presence of sound. Most often it converts the changing pressure associated with sound into an electrical voltage that duplicates the changes. It can be composed of one of the following types:</p> <p><b>Capacitor (Condenser):</b> A microphone that uses the motion of a thin diaphragm caused by the sound to change the capacitance of an electrical circuit and thereby to create a signal. For high sensitivity, this device has a voltage applied across the diaphragm from an internal source.</p> <p><b>Electret:</b> A microphone that uses the motion of a thin diaphragm caused by the sound to change the capacitance of an electrical circuit and thereby to create a signal. The voltage across the diaphragm is caused by the charge embedded in the electret material so no internal source is needed.</p> <p><b>Microphone - Uses:</b> The frequency response of microphones can be adjusted to be used in specific applications. Among those used are:</p> <p><b>Frontal incidence (Free Field):</b> The microphone has been adjusted to have an essentially flat frequency response when in a space relatively free of reflections and when pointed at the source of the sound.</p> <p><b>Random incidence:</b> The microphone has been adjusted to have an essentially flat frequency response for sound waves impinging on the microphone from all directions.</p> <p><b>Pressure:</b> The microphone has not been adjusted to have an essentially flat frequency response for sound waves impinging on the microphone from all directions.</p>

**What a microphone measures:** *A microphone detects more than just sound.* The motion of a microphone diaphragm is in

**Microphone Guidelines, cont.** response to a force acting on it. The force can be caused by a number of sources only one of which are we interested: sound. Non-sound forces are: (1) direct physical contact such as that with a finger or a raindrop; (2) those caused by the movement of air over the diaphragm such as environmental wind or blowing; (3) those caused by vibration of the microphone housing; and (4) those caused by strong electrostatic fields.

*Rules:*

1. Do not permit any solid or liquid to touch the microphone diaphragm. Keep a protective grid over the diaphragm.
2. Do not blow on a microphone and use a wind screen over the microphone to reduce the effect of wind noise.
3. Mount microphones so their body is not subject to vibration, particularly in direction at right angles to the plane of the diaphragm.
4. Keep microphones away from strong electrical fields.

*A microphone measures forces not pressures.* We would like the microphone to measure sound pressure (force per unit area) instead of sound force. If the pressure is applied uniformly over the microphone diaphragm a simple constant (the diaphragm area) relates the two, but if the pressure varies across the diaphragm the relationship is more complex. For example, if a negative pressure is applied on one-half the diaphragm and an equal positive pressure is applied to the other half, the net force is zero and essentially no motion of the diaphragm occurs. This occurs at high frequencies and for specific orientations of the microphone.

*Rules:*

1. Do not use a microphone at frequencies higher than specified by the manufacturer; to increase the frequency response choose smaller microphones.
2. Choose a microphone for *free field* or *random incidence* to minimize the influence of orientation.

*A microphone influences the sound being measured.* The microphone measures very small forces, low level sound can run about one-billionth of a PSI! Every measurement instrument changes the thing being measured, and for very small forces that effect can be significant. When sound impinges directly on a microphone the incident wave must be reflected since it cannot pass through the microphone. This results in the

extra force required to reflect the sound and a microphone output that is higher than would exist if the microphone were not there. This is more important at high frequencies and when the microphone is facing the sound source.

*Rules:*

1. Do not use a microphone at frequencies higher than specified by the manufacturer; to increase the frequency response choose smaller microphones.
2. Choose a microphone for *free field* or *random incidence* to minimize the influence of orientation.

*A microphone measures what is there from any direction:* Most measurements are intended to measure the sound level of a specific source, but most microphones are not directional so they measure whatever is there, regardless of source.

*Rules:*

1. When making hand-held measurements, keep your body at right angles to the direction of the sound you are interested in and hold the meter as far from your body as possible. Use a tripod whenever possible.
2. Measure the influence of other sources by measuring the background sound level without the source of interest. You may have to correct for the background.

## Near Field

There are two types of near fields: the *acoustic near field* and the *geometric near field*.

*Acoustic Near Field:* The distance from a source of sound is less than an acoustic wavelength. In the near field, the effect of the type of sound source is significant. Since the wavelength varies with frequency (See the definition of Wavelength), the distance will vary with frequency. The most common example of a near field is driving an automobile with an open window. As you move your ear to the plane of the window, the sound pressure level builds up rapidly (wind noise) since most of the pressure changes are to move the air and very little of it compresses the air to create sound. Persons not far way, can hardly hear what you hear. The acoustic near field is characterized by pressures that do not create sound that can be measured in the far field. Therefore measurements made here are not useful in predicting the sound levels far way or the sound power of the source.

*Geometric Near Field:* The distance from a source of sound is less than the largest dimension of the sound source. In the near field, effect of source geometry is significant. Sound

sources often have a variety of specific sources within them, such as exhaust and intake noise. When in the near field, the sound of a weaker, but close, source can be louder than that of a more distant, but stronger, source. Therefore measurements made here can be used to separate the various sources of sound, but are not useful in predicting the sound levels and sound spectrum far from the source.

## Noise

Typically it is *unwanted* sound. This word adds the response of humans to the physical phenomenon of sound. The descriptor should be used only when negative effects on people are known to occur. Unfortunately, this word is used also to describe sounds with no tonal content (random):

*Ambient:* The all encompassing sound at a given location caused by all sources of sound. It is generally random, but need not be.

*Background:* The all encompassing sound at a given location caused by all sources of sound, but excluding the source to be measured. It is essentially the sound that interferes with a measurement.

*Pink:* It is a random sound that maintains constant energy per octave. Pink light is similar to pink noise in that it has a higher level at the lower frequencies (red end of the spectrum).

*White:* It is a random sound that contains equal energy at each frequency. In this respect, it is similar to white light.

## Noise Dose (D)

It is the percentage of time a person is exposed to noise that is potentially damaging to hearing. Zero represents no exposure and 100 or more represents complete exposure. It is calculated by dividing the actual time of exposure by the allowed time of exposure. The allowed time of exposure is determined by the Criterion Duration and by the sound level (the higher the level, the shorter the allowed time). The sound levels must be measured with A-frequency weighting and slow exponential time weighting. See Projected Noise Dose.

where  $T$  is the Measurement Duration and  $T_i$  is the Allowed Exposure Time.

*Standard:* ANSI S12.19

## Noise Exposure

(See Sound Exposure)



$$D = 100 \frac{T}{T_i} = \frac{100T}{T_c} 10^{(L_i - L_c)/Q}$$

<b>OSHA Level (L<sub>OSHA</sub>)</b>	The Average Sound Level calculated in accordance with the Occupational Safety and Health Administration Exchange Rate and Threshold Level.
<b>Preamplifier</b>	A part of the sound level meter that matches a particular model of microphone to the meter. It must be chosen in conjunction with a microphone and a cable that connects them.
<b>Projected Noise Dose</b>	It is the Noise Dose expected if the current rate of noise exposure continues for the full Criterion Duration period.
<b>Single Event Noise Exposure Level (SENEL, L<sub>AX</sub>)</b>	The total sound energy over a specific period. It is a special form of the Sound Exposure Level where the time period is defined as the start and end times of a noise event such as an aircraft or automobile passby.
<b>Sound</b>	<p>The rapid oscillatory compressional changes in a medium (solid, liquid or gas) that propagate to distant points. It is characterized by changes in density, pressure, motion, and temperature as well as other physical quantities. Not all rapid changes in the medium are sound (wind noise) since they do not propagate.</p> <p>The auditory sensation evoked by the oscillatory changes.</p> <p><i>Difference between sound and noise:</i> Sound is the physical phenomenon associated with acoustic (small) pressure waves. Use of the word <i>sound</i> provides a neutral description of some acoustic event. Generally, noise is defined as unwanted sound. It can also be defined as sound that causes adverse effects on people such as hearing loss or annoyance. It can also be defined as the sound made by other people. In every case, noise involves the judgment of someone and puts noise in the realm of psychology not physics.</p> <p><i>Rules:</i></p> <ol style="list-style-type: none"> <li>1. Use word <i>sound</i> to describe measurements to remove the emotional overtones associated with the word <i>noise</i>. Some</li> </ol>

sound metrics use noise in their name and it is proper to use the name as it is.

### Sound Exposure (SE)

It is the total sound energy of the actual sound during a specific time period. It is expressed in Pascals-squared seconds.

$$SE = \int_{T_1}^{T_2} p_A^2(t) dt$$

where  $p_A$  is the sound pressure and  $T_2 - T_1$  is the Measurement Duration (specific time period).

When applied to hearing damage potential, the equation is changed to

$$SE = \int_{T_1}^{T_2} [p_A^2(t)]^k dt$$

where  $k$  is the Exposure Factor. See Exchange Rate.

*Standard:* ANSI S1.25

**Sound Exposure Level (SEL,  $L_{ET}$ )** The total sound energy in a specific time period. The equation for it is

$$SEL = 10 \log_{10} \left[ \frac{\int_{T_1}^{T_2} p^2(t) dt}{p_0^2 T} \right]$$

The sound pressure is squared and integrated over a specific period of time ( $T_2 - T_1$ ) this is called the sound exposure and has the units Pascal squared- seconds or Pascal squared-hours.  $P_0$  is the reference pressure of 20  $\mu$ Pa and  $T$  is the reference time of 1 second. It is then put into logarithmic form. It is important to note that it is not an average since the reference time is not the same as the integration time.

### Sound Pressure

The physical characteristic of sound that can be detected by microphones. Not all pressure signals detected by a micro-

phone are sound (e.g., wind noise). It is the amplitude of the oscillating sound pressure and is measured in Pascals (Pa), Newtons per square meter, which is a metric equivalent of pounds per square inch. To measure sound, the oscillating pressure must be separated from the steady (barometric) pressure with a detector. The detector takes out the steady pressure so only the oscillating pressure remains. It then squares the pressure, takes the time average, and then takes the square root (this is called rms for root-mean square). There are several ways this can be done.

*Moving Average:* The averaging process is continually accepting new data so it is similar to an exponential moving average. The equation for it is

$$p_{rms} = \sqrt{\frac{1}{T} \int_{t_s}^t p^2(\xi) e^{-(t-\xi)/T} d\xi}$$

The sound pressure is squared and multiplied by an exponential decay factor so that when the time of integration is near the current time (t) it is essentially undiminished. For times older (less) than the current time, the value is diminished and so becomes less important. The rate at which older data are made less influential is expressed by the constant T. The larger it is the slower the decay factor reduces and the slower the response of the system to rapid changes. These are standardized into three values called Time Weighting. See the values below.

*Fixed Average:* The averaging process is over a fixed time period. The equation for it is

$$p_{rms} = \sqrt{\frac{1}{(T_2 - T_1)} \int_{T_1}^{T_2} p^2(t) dt}$$

The sound pressure is squared and averaged over a fixed time period. Unlike the moving average, the sound pressures in all time intervals are equally weighted.

**Sound Pressure Level (SPL,  $L_p$ )** The logarithmic form of sound pressure. It is also expressed by attachment of the word decibel to the number. The logarithm is taken of the ratio of the actual sound pressure to a reference sound pressure which is 20 MicroPascals ( $\mu$  Pa). There are various descriptors attached to this level depending on how the actual sound pressure is processed in the meter:

*Instantaneous:* The time varying reading on a meter face on in a meter output due to changes in the sound pressure. The reading will depend on the time-weighting applied.

The fundamental relationship between the two is logarithmic

$$L_p = 20 \log_{10} \left[ \frac{p_{rms}}{p_0} \right] \quad p_{rms} = p_0 10^{L_p/20}$$

where  $p_0$  is the reference sound pressure of 20  $\mu$ Pa. The square of the sound pressure is a power-like quantity that can be expressed in the original form of the level definition

$$L_p = 10 \log_{10} \left[ \frac{p_{rms}^2}{p_0^2} \right] \quad p_{rms}^2 = p_0^2 10^{L_p/10}$$

Sound Pressure Level can be converted to sound pressure as follows. If the sound pressure is 1 Pascal, then the sound pressure level is

$$L_p = 20 \log_{10} \left[ \frac{1}{20 \bullet 10^{-6}} \right] = 20 \log_{10} [50000] = 20 [4.699] = 94.0 \text{ dB}$$

Calibrators often use a level of 94 dB so they generate a sound pressure of 1 Pascal.

If the sound pressure level = 76.3 dB, then the sound pressure is

$$Pa = 20 \bullet 10^{-6} \bullet 10^{76.3/20} = 20 \bullet 10^{3.815-6} = 20 \bullet 10^{-2.185} = 20 [0.0065] = 0.13$$

*Energy Average ( $L_{eq}$ ):* The value of a steady sound measured over a fixed time period that has the same sound energy as

the actual time varying sound over the same period. This descriptor is widely used. It is a fixed average (See Sound Pressure).

*Impulse:* The value of an impulsive sound. The reading will depend on the time-weighting applied.

*Unweighted Peak:* The peak value of a sound with a meter that has flat frequency weighting and a peak detector.

*Weighted Peak:* The peak value of a sound with a meter that has a frequency weighting other than flat and a peak detector.

**Sound Power(W)**

The sound power emitted by a sound source. It is measured in Watts.

**Sound Power Level (PWL,  $L_w$ )**

The logarithmic form of sound power. It is also expressed by attachment of the word decibel to the number. The logarithm is taken of the ratio of the actual sound power to a reference sound power, which is 1 pico-watt. Sound power level cannot be measured directly, but can only be deduced through measurements of sound intensity or sound pressure around the source. The equation for it is

$$L_w = 10 \log_{10} \left[ \frac{W}{W_0} \right] \quad W = W_0 10^{L_w/10}$$

**Sound Speed, (c)**

The speed at which sound waves propagate. It is measured in meters per second. It should not be confused with sound or particle velocity which relates to the physical motion of the medium itself.

$$c = 20.05 \sqrt{\text{degC} + 273} \quad \text{m/sec}$$

$$c = 49.03 \sqrt{\text{degF} + 460} \quad \text{ft/sec}$$

**Spectrum (Frequency Spectrum)**

The amplitude of sound or vibration at various frequencies. It is given by a set of numbers that describe the amplitude at each frequency or band of frequencies. It is often prefixed with a descriptor that identifies it such as sound

pressure spectrum. It is generally expressed as a spectrum level.

**Threshold Sound Level (Lt)** The A-weighted sound level below which the sound produces little or no Noise Dose accumulation and may be disregarded. It is used for hearing damage risk assessment.  
*Standard: ANSI S1.25*

**Time Weighted Average Sound Level (TWA,  $L_{TWA(TC)}$ )** It is the level of a constant sound over the Criterion Duration, that would expose a person to the same Noise Dose as the actual (unsteady) sound over the same period. If the Exchange Rate is 3 dB then the TWA is equal to the  $L_{eq}$ .

$$L_{TWA(TC)} = K \log_{10} \left( \frac{1}{T} \int_{T_1}^{T_2} 10^{(L_p(t))/K} dt \right)$$

where  $T_c = T_2 - T_1$  and K is the Exchange Rate Factor. It is used for hearing damage risk assessment.  
*Standard: ANSI S12.19*

**Time Weighting** The response speed of the detector in a sound level meter. There are several speeds used.

*Slow:* The time constant is 1 second (1000 ms). This is the slowest and is commonly used in environmental noise measurements.

*Fast:* The time constant is 1/8 second (125 ms). This is a less commonly used weighting but will detect changes in sound level more rapidly.

*Impulse:* The time constant is 35ms for the rise and 1.5 seconds (1500 ms) for the decay. The reason for the double constant is to allow the very short signal to be captured and displayed.

**Vibration** The oscillatory movement of a mechanical system (generally taken to be solid). It is used as a broad descriptor of oscillations.

**Wavelength (l)**

The distance between peaks of a propagating wave with a well defined frequency. It is related to the frequency through the following equation

$$\lambda = \frac{c}{f}$$

where  $c$  is the sound speed and  $f$  is the frequency in Hz. It has the dimensions of length.

**Wavenumber (k)**

A number that is related to the wavelength of sound and is used to compare the size of objects relative to the wavelength or the time delay in sound propagation. It is related to wavelength through the following equation

$$k = \frac{2\pi}{\lambda} = \frac{2\pi f}{c} = \frac{\omega}{c}$$

where  $\lambda$  is the wavelength,  $c$  is the sound speed,  $f$  is the frequency in Hz, and  $\omega$  is the radian frequency. It has the dimensions of inverse length.

**Yearly Average Sound Level (YDNL,  $L_{ydn}$ )** The Day-Night Average Sound Level for each day is averaged over the entire year. It is calculated as follows

$$L_{ydn} = 10 \log \left[ \frac{1}{365} \sum_{i=1}^{365} 10^{L_{dn_i}/10} \right]$$





# D

## *Warranty/Customer Satisfaction*

**A. Total Customer Satisfaction.** Larson Davis, Inc. ("LD") guarantees Total Customer Satisfaction. If, at any time you are not completely satisfied with any LD product, LD will repair, replace or exchange it at no charge, except as otherwise provided in this Limited Warranty. The employees of LD strive to provide superior, unmatched customer service. Should you find yourself dissatisfied with any LD product for any reason, consult a LD Application engineer or local representative/ distributor to discuss your situation.

**B. Purchase Price Refund/Limited Warranty.** LD warrants to the original purchaser (the "Buyer") that, unless otherwise expressly specified in writing by a LD officer, all LD products shall be free of defects in material and workmanship for a period of two (2) years from date of original purchase. In furtherance of LD's commitment to Total Customer Satisfaction, LD will, for a period of one (1) year from date of original purchase, refund 100% of the customer's purchase price for any LD product with which the buyer is not completely satisfied, subject to the exceptions contained in Paragraph J of this Limited Warranty. The option of a refund may be selected during this one (1) year period in lieu of repair, replacement or exchange of the product.

**Extended Labor Warranty.** In furtherance of LD's commitment to Total Customer Satisfaction, LD offers an extended labor warranty of one (1) year on all products calibrated or certified by a factory technician at any time or from time-to-time during the first seven years of the product life from date of manufacture. The customer's sole remedy pursuant to this extended warranty is to receive free labor for any repairs required during the period in which the extended warranty is effective. This extended labor warranty is subject to the limitations as outlined in Paragraph J.

**Service & Repair Limited Warranty.** In addition to the limited warranties set forth above, LD offers a 90-day parts and labor limited warranty for all repair work performed at the factory. This warranty is limited to parts repaired or replaced at the factory by LD. This warranty is also subject to the limitations as outlined in Paragraph J.

**C. Shipping Charges.** The buyer will return the product freight prepaid by the Buyer to an authorized service center. The product will be returned to the buyer freight prepaid by LD.

**D. Products Manufactured by Others.** This Limited Warranty does not cover any products manufactured by others. Such products are subject to the warranty, if any, of their respective manufacturers, and to be repaired only by a respective authorized service person for such products. LD shall have no obligation to undertake repairs of products manufactured by others.

**E. NO SPECIAL, INCIDENTAL OR CONSEQUENTIAL DAMAGES. LD'S SOLE OBLIGATIONS UNDER THIS LIMITED WARRANTY ARE SET FORTH ABOVE IN PARAGRAPHS A, B, C AND D. IN NO EVENT SHALL LD (ITS CONTRACTORS OR SUPPLIERS) BE LIABLE TO THE BUYER FOR ANY LOST PROFITS, DIRECT, INDIRECT, SPECIAL, INCIDENTAL OR CONSEQUENTIAL DAMAGES, WHETHER BASED ON CONTRACT, IN TORT OR ANY OTHER LEGAL THEORY. SUCH DAMAGES FOR WHICH LD SHALL NOT BE RESPONSIBLE INCLUDE, BUT ARE NOT LIMITED TO, LOST TIME AND CONVENIENCE, LOSS OF USE OF THE PRODUCT, THE COST OF A PRODUCT RENTAL, COSTS OF GASOLINE, TELEPHONE, TRAVEL OR LODGING, THE LOSS OF PERSONAL OR COMMERCIAL PROPERTY, AND THE LOSS OF REVENUE.**

Some states do not permit the limitation or disclaimer of incidental or consequential damages. Therefore, the above disclaimer of incidental or consequential damages may not apply to certain purchasers.

**F. NO LIABILITY IN EXCESS OF PURCHASE PRICE. IN NO EVENT SHALL LD'S OBLIGATIONS UNDER THIS LIMITED WARRANTY EXCEED THE PURCHASE PRICE OF THE PRODUCT PLUS ANY SHIPPING CHARGES THAT LD MAY BE OBLIGATED TO PAY PURSUANT TO PARAGRAPH C ABOVE.**

**G. NO EXTENSION OF STATUTE OF LIMITATIONS. ANY REPAIRS PERFORMED UNDER THIS LIMITED WARRANTY SHALL NOT IN ANY WAY EXTEND THE STATUTES OF LIMITATIONS FOR CLAIMS UNDER THIS LIMITED WARRANTY.**

**H. WAIVER OF OTHER WARRANTIES. THE EXPRESS WARRANTIES SET FORTH IN THIS LIMITED WARRANTY ARE IN LIEU OF AND EXCLUDE ANY AND ALL OTHER WARRANTIES, EXPRESSED OR IMPLIED, INCLUDING BUT NOT LIMITED TO, THE IMPLIED WARRANTIES OF MERCHANTABILITY AND FITNESS FOR A PARTICULAR PURPOSE.**

Some states do not permit the disclaimer of implied warranties. Therefore, the above disclaimer of implied warranties may not apply to certain purchasers.

**I. Procedure for Warranty Performance. If the product fails to perform to LD's specifications, the Buyer must provide LD with the applicable model and serial numbers, the date of purchase, and the nature of the problem.**

**J. ADDITIONAL EXCLUSIONS FROM THIS LIMITED WARRANTY. NOTWITHSTANDING ANYTHING TO THE CONTRARY CONTAINED IN THIS LIMITED WARRANTY, THIS LIMITED WARRANTY DOES NOT COVER ANY OF THE FOLLOWING:**

**1.EQUIPMENT THAT HAS BEEN ABUSED, DAMAGED, USED BEYOND RATED CAPACITY, OR REPAIRED BY PERSONS OTHER THAN AUTHORIZED SERVICE PERSONNEL.**

**2.DAMAGE CAUSED BY ACTS OF GOD THAT INCLUDE, BUT ARE NOT LIMITED TO, HAILSTORMS, WINDSTORMS, HURRICANES, TORNADOES, SANDSTORMS, LIGHTNING, FLOODS AND EARTHQUAKES.**

**3.DAMAGE UNDER CONDITIONS CAUSED BY FIRE OR ACCIDENT, BY ABUSE OR BY NEGLIGENCE OF THE USER OR ANY OTHER PERSON OTHER THAN LD, BY IMPROPER INSTALLATION, BY MISUSE, BY INCORRECT OPERATION, BY “NORMAL WEAR AND TEAR”, BY IMPROPER ADJUSTMENT OR ALTERATION, BY ALTERATIONS NOT COMPLETED BY AUTHORIZED SERVICE PERSONNEL, OR BY FAILURE OF PRODUCTS PARTS FROM SUCH ALTERATIONS.**

**4.COSTS OF REPAIRING DAMAGE CAUSED BY POOR OR IMPROPER MAINTENANCE OR UNAUTHORIZED REPAIR.**

**5.COSTS OF MODIFYING THE PRODUCT IN ANY WAY ONCE DELIVERED TO THE BUYER, EVEN IF SUCH MODIFICATIONS WERE ADDED AS A PRODUCTION CHANGE ON OTHER PRODUCTS MADE AFTER THE BUYER'S PRODUCT WAS BUILT.**

**Authority to Alter This Limited Warranty.** No agent, representative, distributor, or authorized dealer of LD has any authority to alter the terms of this Limited Warranty in any way. This Limited Warranty may be altered only in a writing signed by an authorized officer of LD.



---

# Index

## A

- AC
  - output specifications .....A-9
- American National Standards Institute (ANSI) .....1-5
- ANSI
  - standards met .....A-11

## B

- Battery
  - internal life of .....1-18
- Battery Voltage
  - directions for checking .....2-11
- Baud Rate .....8-8

## C

- Calendar
  - real-time .....A-11
- Calibration .....1-6,  
3-1, .....8-11,  
C-1
  - glossary .....C-2
- calibration .....3-2
- Character Parameters .....B-14
- Clock
  - real-time .....A-11
  - run-time .....A-11
- clock .....8-7
- Commands
  - status .....B-6
- Criterion .....8-12,  
C-2
  - sound level .....C-3

## D

- Daily History .....8-17
- Data
  - time history .....7-3
- Date .....8-8
- Dc

- output specifications .....A-8
- Decibel .....C-3
- Department of Defense
  - level .....C-5
- Detector .....8-11,  
C-5
- Display
  - digital .....A-10
- Duration
  - measurement .....C-9
- Dynamic range .....1-5

## E

- EEPROM
  - Register .....8-5
- Environment
  - effects of Temperature .....A-7
- Error .....B-31
  - messages and warnings .....B-31
- Error Checking
  - I/O .....B-23
- Exceedance .....8-14
- Exceedance History .....8-14
- Exchange Rate .....8-12
  - glossary .....C-5
- Exchange Rate Factor
  - glossary .....C-5
- Exposure Factor
  - glossary .....C-5

## F

- Far Field .....C-6
  - acoustic .....C-6
  - geometric .....C-6
- Formatting Conventions .....1-3
- Free field .....C-6
- Frequency
  - band pass filter .....C-7
  - glossary .....C-6
  - Hz, rad/sec .....C-7
- Frequency Weightings

---

specifications .....A-4  
frequency weightings .....1-5

## H

Histogram  
    variables .....B-29  
Histogram Reports .....B-20  
History  
    commands .....B-5  
    records .....B-25  
Hysteresis .....8-14

## I

I/O Error Checking .....B-23  
indexed .....B-13  
Indexed Parameters .....B-13  
interface .....8-7  
International Electrotechnical Commission  
    (IEC) .....1-5  
Interval History .....8-14  
Interval Variables .....B-26  
Intrusion alarm .....B-17

## K

Key  
    Lmin/Lmax .....8-14  
key  
    shift .....2-9  
keys  
    functions of .....2-3

## L

Leq  
    glossary .....C-5  
Level .....C-9  
    Dept of Defense .....C-5  
LN  
    Ln Statistical Levels .....8-13  
LN Statistical Levels .....8-13  
Lock .....8-11

## M

Messages

error messages and warnings .....B-31  
Microphone  
    guidelines .....C-9  
    what it measures .....C-10

microphone  
    reference number .....1-13

Microphone Extension Cables  
    specifications .....A-8

Microphones  
    capacitor .....C-9  
    electrit .....C-9  
    uses .....C-9

Mode  
    commands .....B-5

Model 812 .....3-1  
    Block Diagram .....1-10  
    Components .....1-7  
    Features .....1-5  
    Keypad .....2-2  
    optional equipment .....1-15  
    Screen .....2-10  
    System Diagram .....1-10

Model 820  
    Glossary, App C .....C-1  
    Specifications, App A .....A-1

## N

Near Field  
    acoustic .....C-11  
    geometric .....C-11  
    glossary .....C-11

Noise  
    ambient .....C-12  
    Background .....C-12  
    compensate .....B-23  
    daily personal exposure .....C-3  
    exposure .....C-13  
    floor .....B-23  
    glossary .....C-2,  
        C-12  
    projected noise dose .....C-13  
    single event exposure level(SENEL,Lax)  
        C-13

numeric .....2-9

---

Numeric Parameters .....B-13

## O

Off

directions for turning off .....2-12

OSHA

level .....C-13

Overload .....2-8

## P

Parameter .....B-13,  
B-15

character .....B-14

character strings .....B-13

Exceedance .....8-14

indexed .....B-13

numeric .....B-13

query .....B-16

setting .....B-13

template .....B-13

Time History Data .....7-3

Peak .....8-16

Pin .....B-3

Pin configurations .....B-3

polarization .....3-1

Power

external .....1-18

specifications .....A-12

Power Save .....8-10

Preamplifier .....C-13

Print .....8-17,

10-1

commands .....B-30

parameters .....10-1

reports .....10-3

## R

RAM

registers .....8-6

Reference Direction

specifications .....A-2

Reference Level .....8-12

specifications .....A-4

Register

RAM .....8-5

Register, EEPROM .....8-5

Reset .....3-4

RESET-ALL .....8-1

RS-232 .....1-6

data communications .....A-10

RS-232 Address .....8-8

RS-232 interface .....B-1

Run Log Variables .....B-28

Run mode .....2-8

## S

serial number .....1-13

Setup

parameters .....8-7

setup

print .....10-3

Setup Memory .....8-4

SLM

Sound Level Meter .....8-11

Sound

average level (lavg) .....C-1

day-night average level .....C-3

energy average (Leq) .....C-16

exposure .....C-14

exposure level .....C-14

fixed average .....C-15

glossary .....C-13

impulse .....C-16

instantaneous .....C-16

intensity(l) .....C-17

moving average .....C-15

pressure .....C-14

sound pressure level(SPL,Lp) .....C-15

unweighted peak .....C-16

weighted peak .....C-17

yearly average level(YDNL, Lydn) C-19

Sound Level

threshold(Lt) .....C-17

Sound Level Meter

SLM .....8-11

Sound Power .....C-17

level(PWL,Lw) .....C-17

---

Sound Pressure Level (see Sound) .....	C-15
Sound Speed .....	C-17
Specifications	
frequency weightings .....	A-4
microphone extension cables .....	A-8
reference direction .....	A-2
reference level .....	A-4
temperature .....	A-7
type .....	A-2
Spectrum	
frequency .....	C-17
Standards	
ANSI .....	A-11
Status	
command .....	B-6

## T

Temperature	
specifications .....	A-7
template .....	B-15
Template Parameters .....	B-15
Threshold .....	8-12
Time	
allowed Exposure time(Ti) .....	C-1
weighting .....	C-18
Time History .....	8-14
data .....	7-3
TWA	
time weighted average sound level(TWA, LTWA(TC) ...	C-18
Type	
specifications .....	A-2
Type 1 .....	1-5

## V

Variables	
calibration history .....	B-28
exceedance history .....	B-26
histogram .....	B-29
histogram table .....	B-29
interval .....	B-26
interval history .....	B-26
run log .....	B-28
time history .....	B-29

Vibration .....	C-18
-----------------	------

## W

Warnings error messages .....	B-31
Warranty .....	D-1
warranty .....	1-7
Wavelength(l)	
glossary .....	C-18
Wavenumber	
glossary .....	C-19
Weighted	
8-hour time weighted average sound level .....	C-5
Weighting .....	8-12
frequency .....	C-7
time .....	C-18
Weightings	
A and C .....	5-4